



ANYA

ARABIAN RANCHES III

FLOOR PLANS

EMAAR

ANYA

ARABIAN RANCHES III

MODERN TOWNHOUSE 4 BEDROOM 1

UNIT	TOTAL AREA	
4PLEX - TH01	2340.61 SQFT	217.45 SQM
6PLEX - TH01	2358.26 SQFT	219.09 SQM
8PLEX - TH01		

KEY PLAN

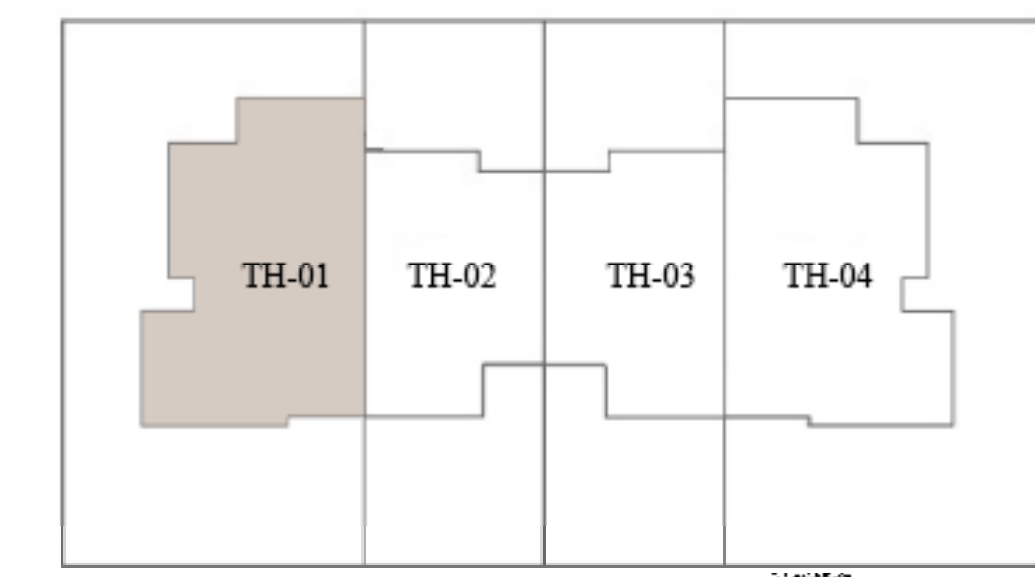

4PLEX - TH01

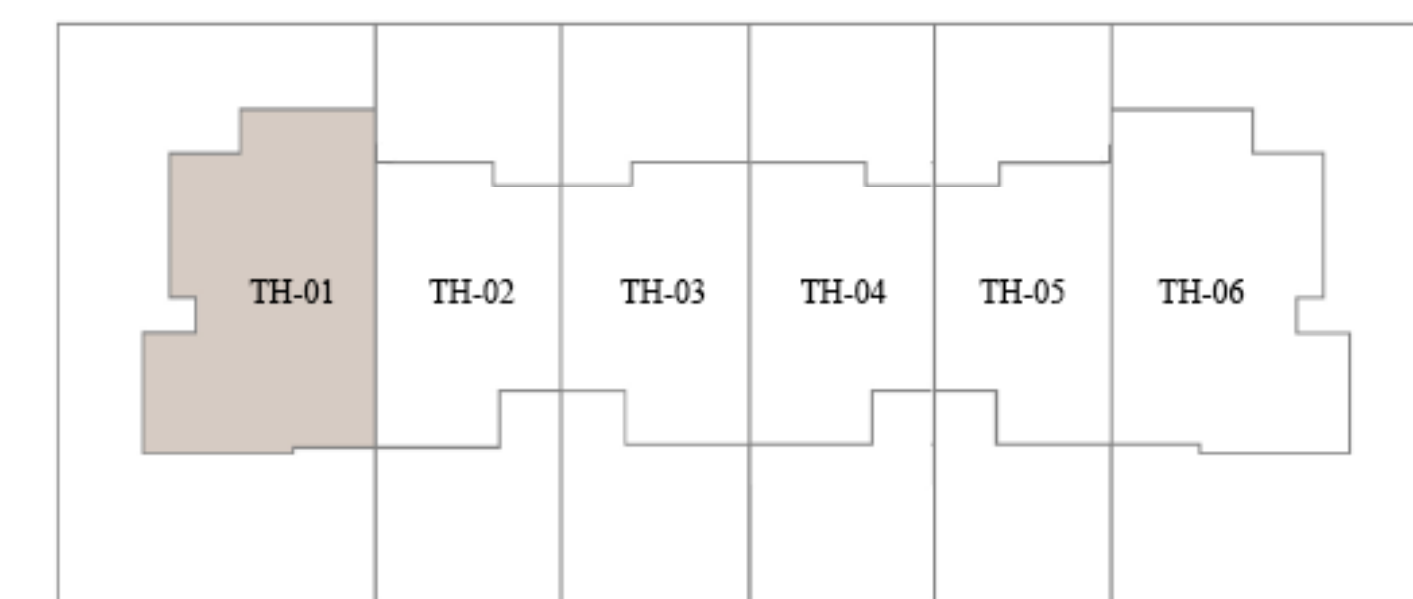

6PLEX - TH01

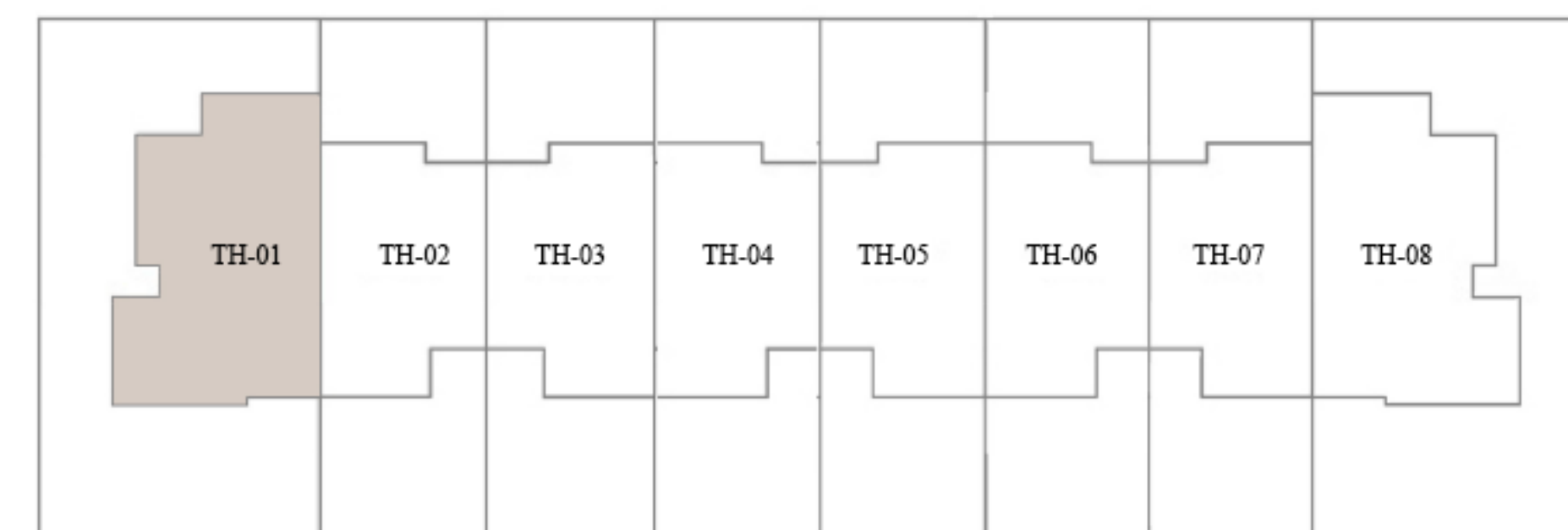

8PLEX - TH01



GROUND FLOOR



FIRST FLOOR

FLOOR PLAN 1. All dimensions are in imperial and metric, and measured from finish to finish excluding construction tolerances. 2. All materials, dimensions, and drawings are approximate only. 3. Information is subject to change without notice, at developer's absolute discretion. 4. Actual area may vary from the stated area. 5. Drawings not to scale. 6. All images used are for illustrative purposes only and do not represent the actual size, features, specifications, fittings, and furnishings. 7. The developer reserves the right to make revisions / alterations, at it's absolute discretion, without any liability whatsoever.

ANYA

ARABIAN RANCHES III

MODERN TOWNHOUSE 4 BEDROOM 1 M MIRRORED

UNIT	TOTAL AREA	
4 PLEX - TH04	2340.61 SQFT	217.45 SQM
6 PLEX - TH06	2358.26 SQFT	219.09 SQM
8 PLEX - TH08		

KEY PLAN

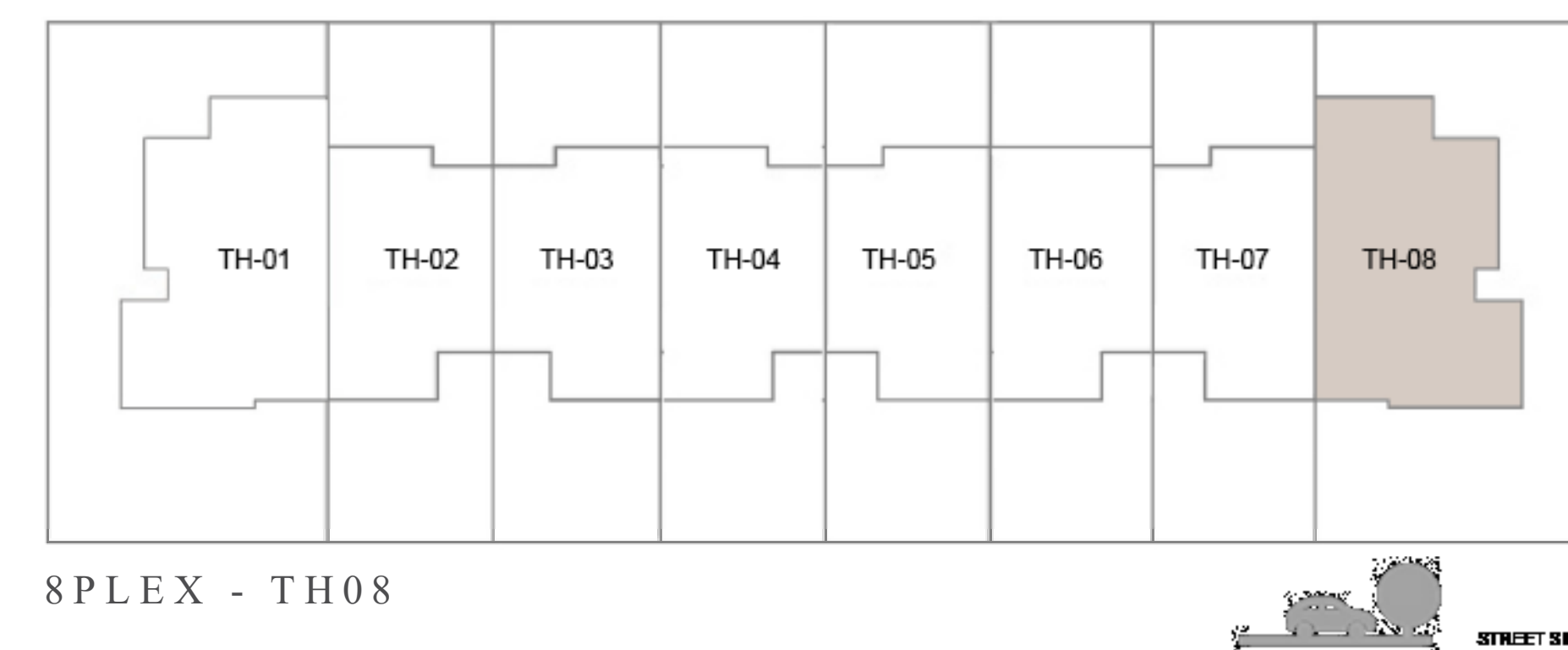
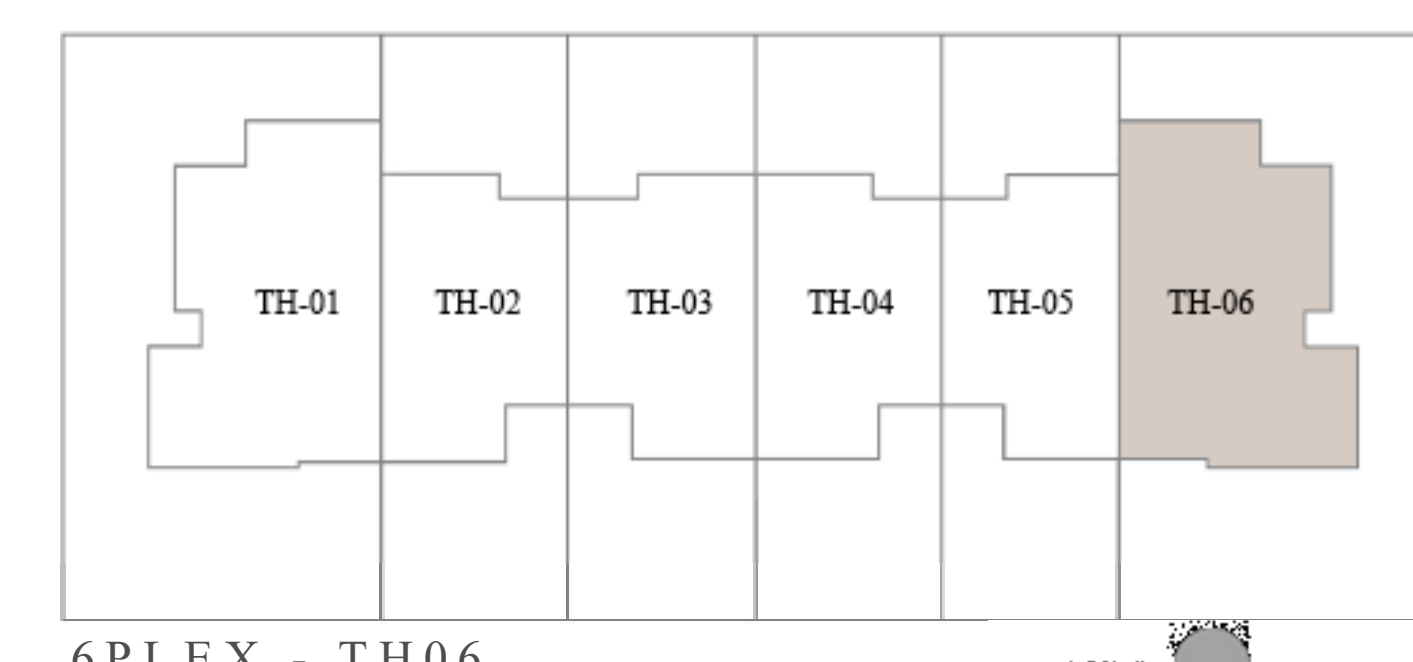
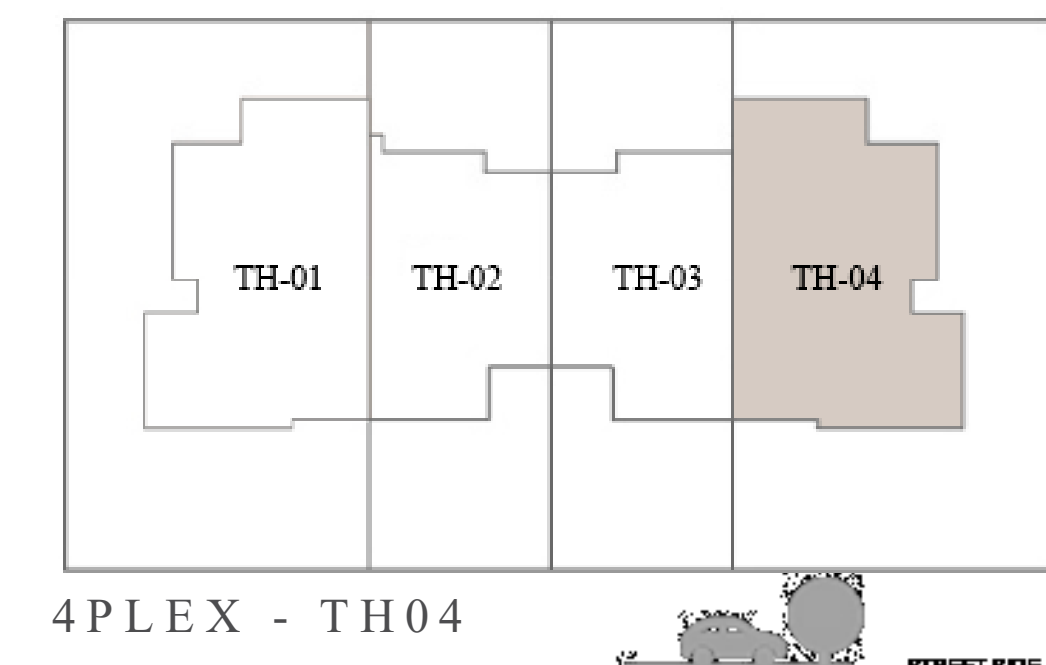

GROUND FLOOR

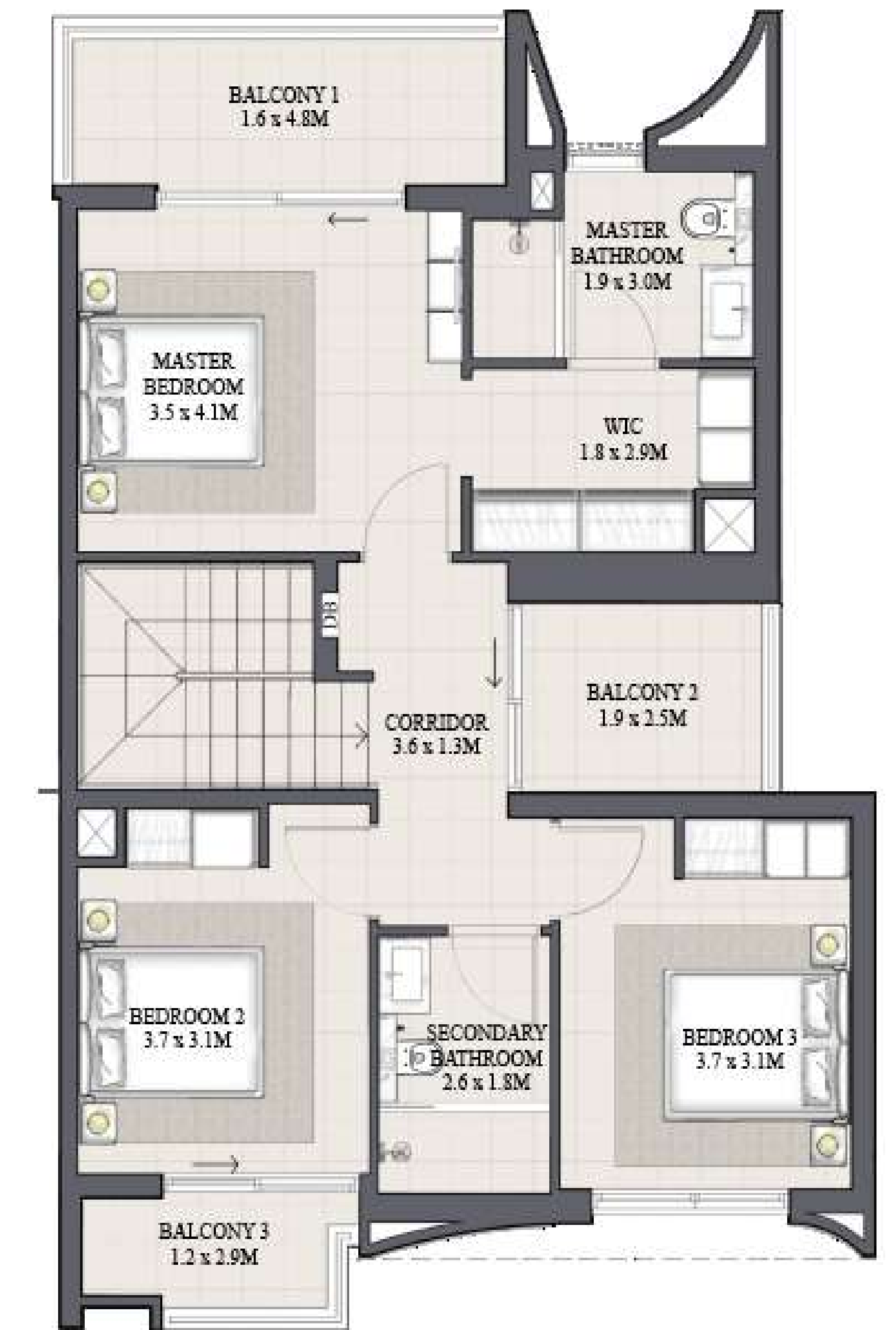

FIRST FLOOR

FLOOR PLAN 1. All dimensions are in imperial and metric, and measured from finish to finish excluding construction tolerances. 2. All materials, dimensions, and drawings are approximate only. 3. Information is subject to change without notice, at developer's absolute discretion. 4. Actual area may vary from the stated area. 5. Drawings not to scale. 6. All images used are for illustrative purposes only and do not represent the actual size, features, specifications, fittings, and furnishings. 7. The developer reserves the right to make revisions / alterations, at it's absolute discretion, without any liability whatsoever.

ANYA

ARABIAN RANCHES III

MODERN TOWNHOUSE 3 BEDROOM 1

UNIT	TOTAL AREA	
4 PLEX - TH02	1935.46 SQFT	179.81 SQM
6 PLEX - TH02	1937.18 SQFT	179.97 SQM
8 PLEX - TH02	1935.46 SQFT	179.81 SQM

KEY PLAN

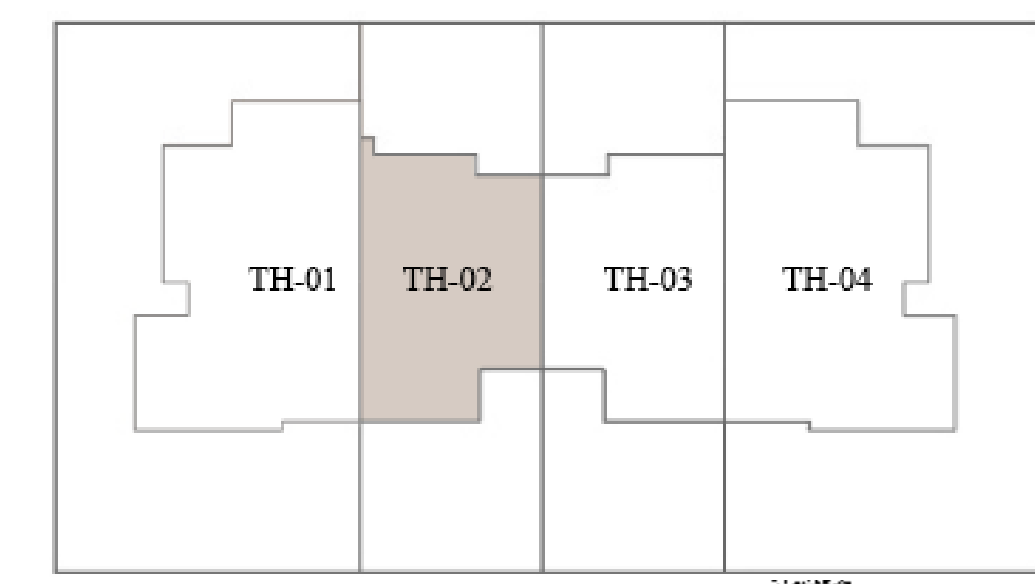

4 PLEX - TH02

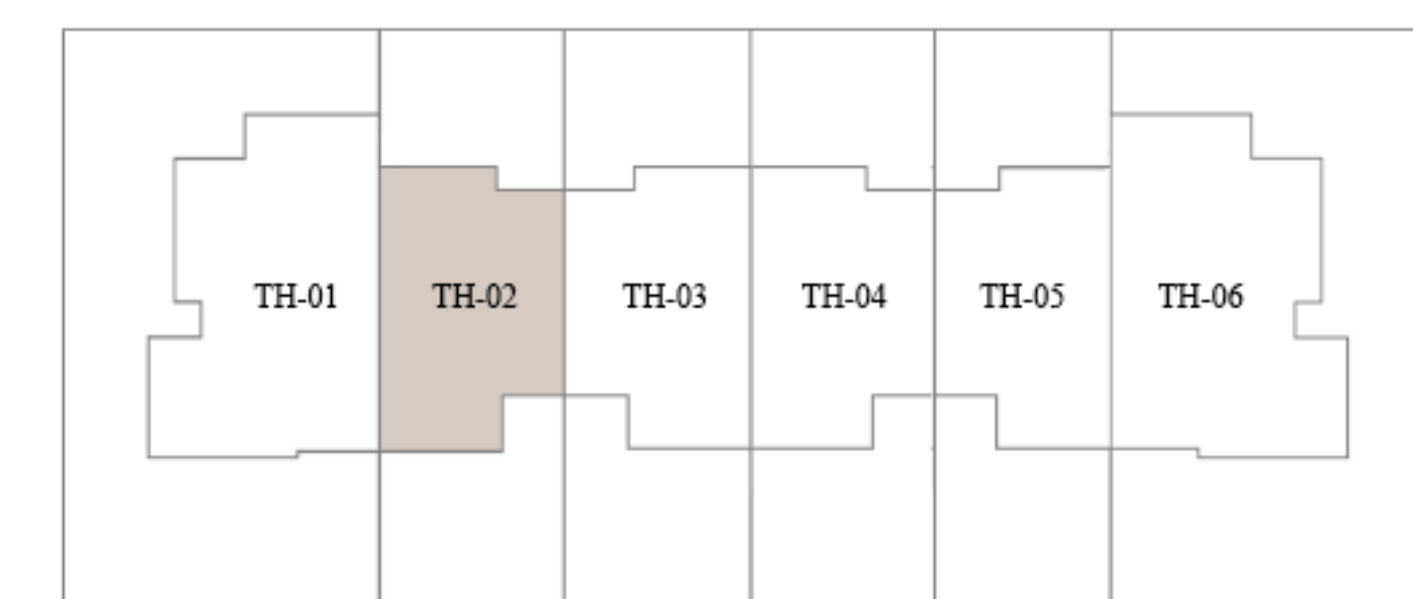

6 PLEX - TH02

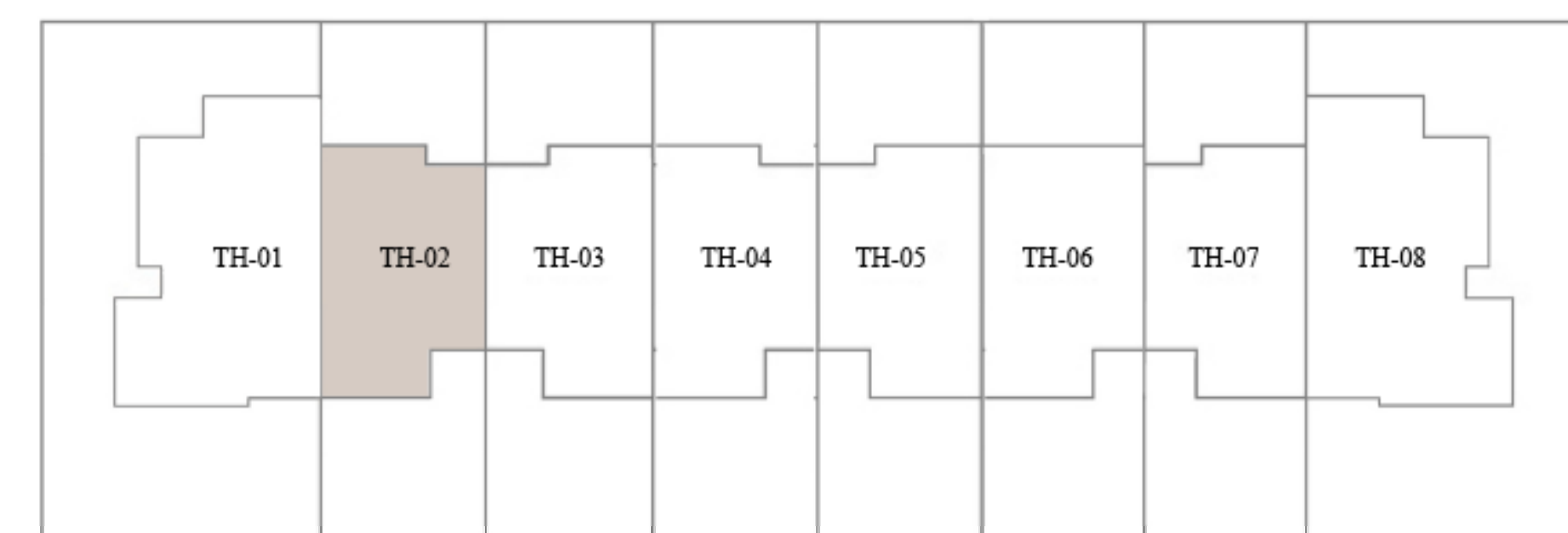

8 PLEX - TH02

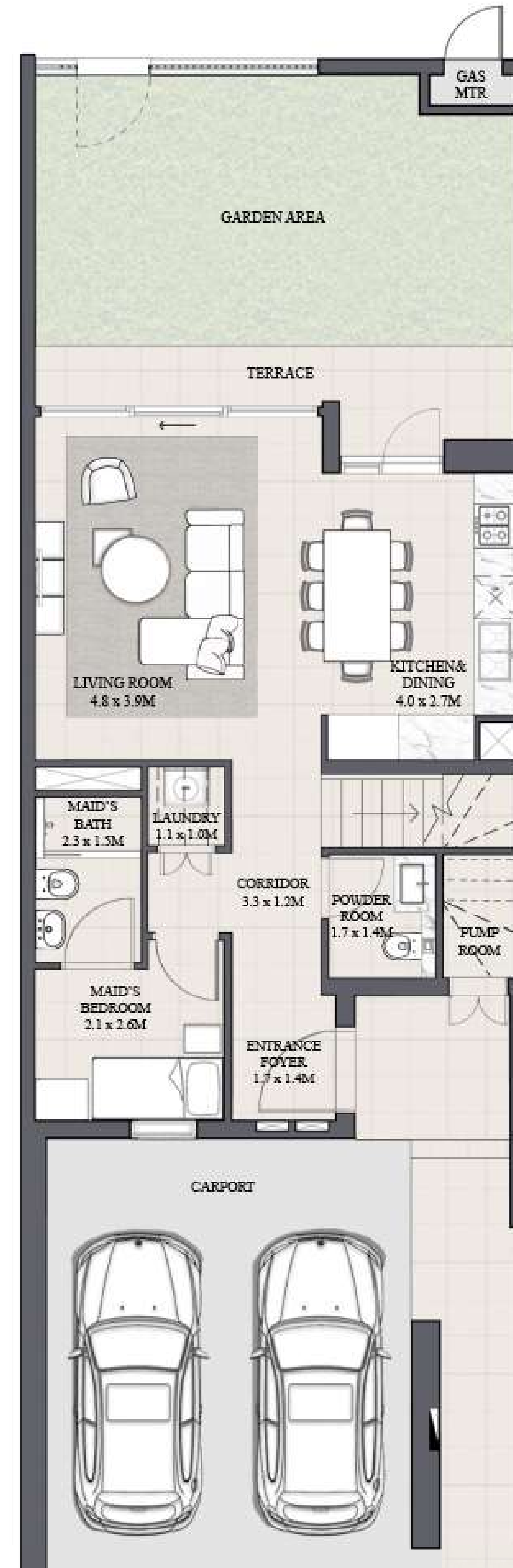

GROUND FLOOR



FIRST FLOOR

FLOOR PLAN 1. All dimensions are in imperial and metric, and measured from finish to finish excluding construction tolerances. 2. All materials, dimensions, and drawings are approximate only. 3. Information is subject to change without notice, at developer's absolute discretion. 4. Actual area may vary from the stated area. 5. Drawings not to scale. 6. All images used are for illustrative purposes only and do not represent the actual size, features, specifications, fittings, and furnishings. 7. The developer reserves the right to make revisions / alterations, at its absolute discretion, without any liability whatsoever.

ANYA

ARABIAN RANCHES III

MODERN TOWNHOUSE 3 BEDROOM 1 M MIRRORED

UNIT	TOTAL AREA	
6 PLEX - TH05	1937.18 SQFT	179.97 SQM
8 PLEX - TH07	1935.46 SQFT	179.81 SQM

KEY PLAN

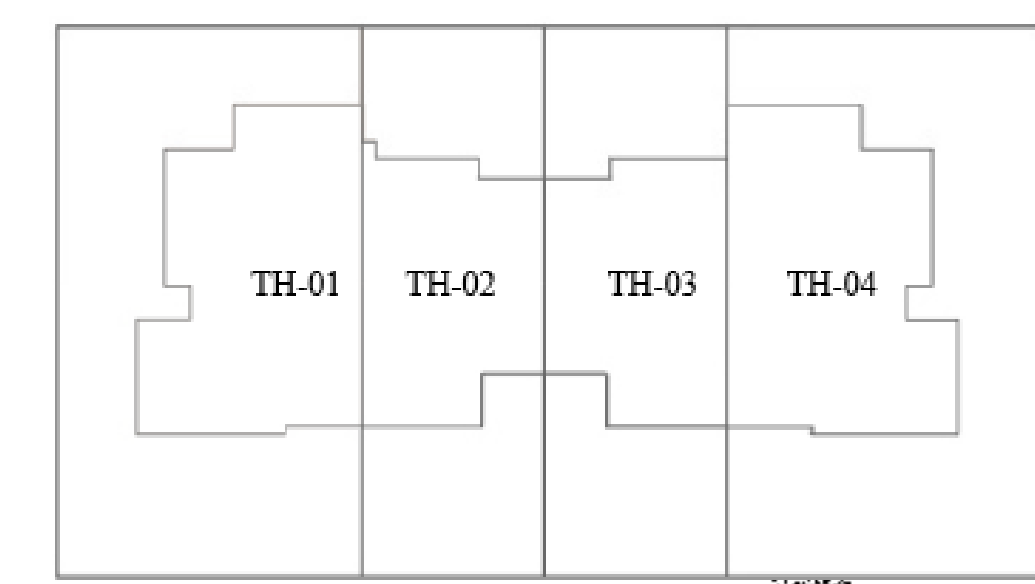

4 PLEX

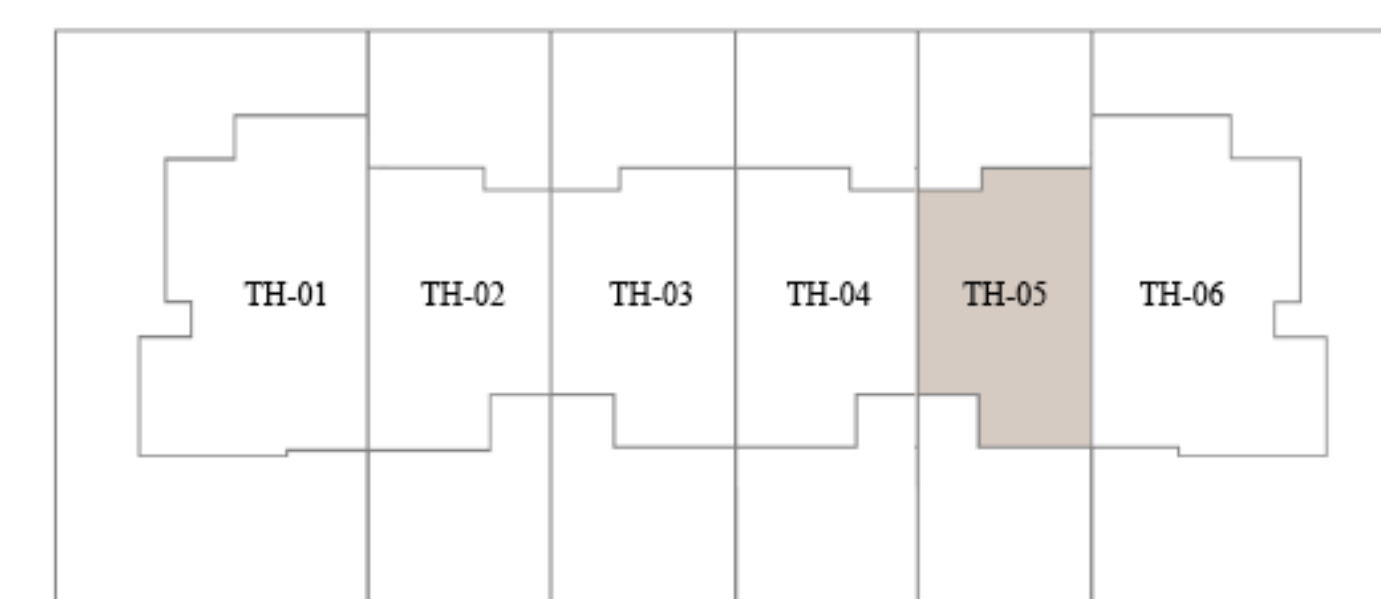

6 PLEX - TH05

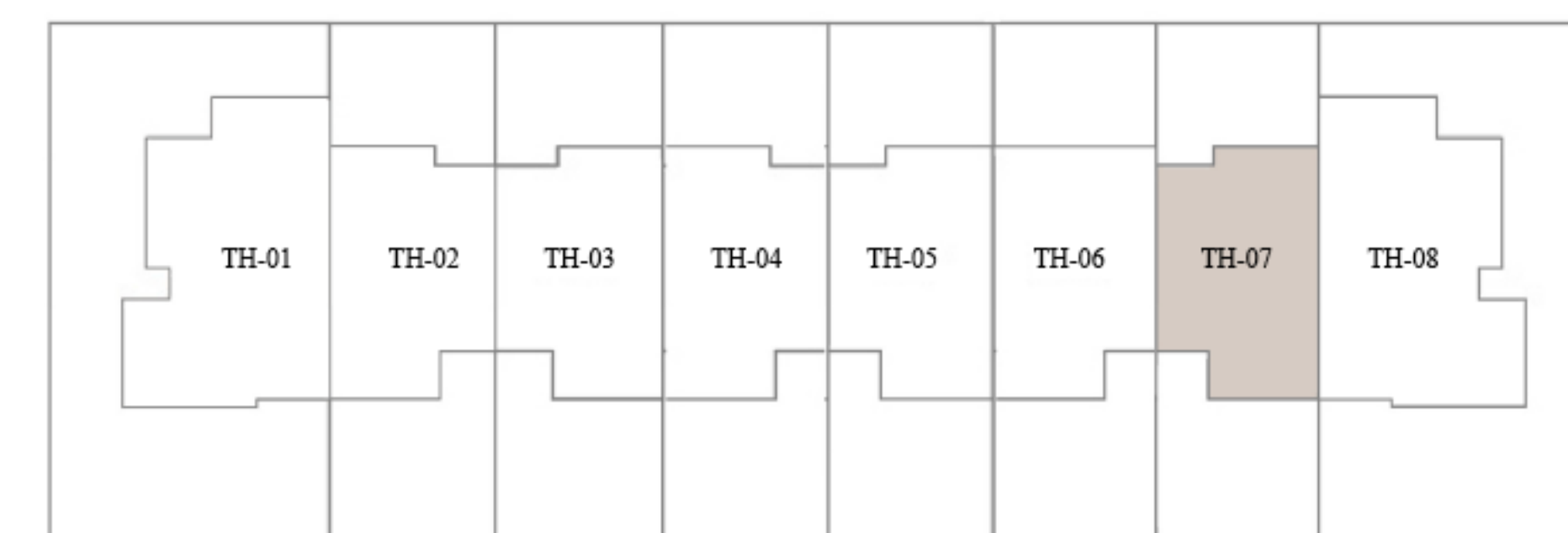

8 PLEX - TH07



GROUND FLOOR



FIRST FLOOR

FLOOR PLAN 1. All dimensions are in imperial and metric, and measured from finish to finish excluding construction tolerances. 2. All materials, dimensions, and drawings are approximate only. 3. Information is subject to change without notice, at developer's absolute discretion. 4. Actual area may vary from the stated area. 5. Drawings not to scale. 6. All images used are for illustrative purposes only and do not represent the actual size, features, specifications, fittings, and furnishings. 7. The developer reserves the right to make revisions / alterations, at it's absolute discretion, without any liability whatsoever.

ANYA

ARABIAN RANCHES III

MODERN TOWNHOUSE 3 BEDROOM 3

UNIT	TOTAL AREA	
6 PLEX - TH03	1912.53 SQFT	177.68 SQM

KEY PLAN

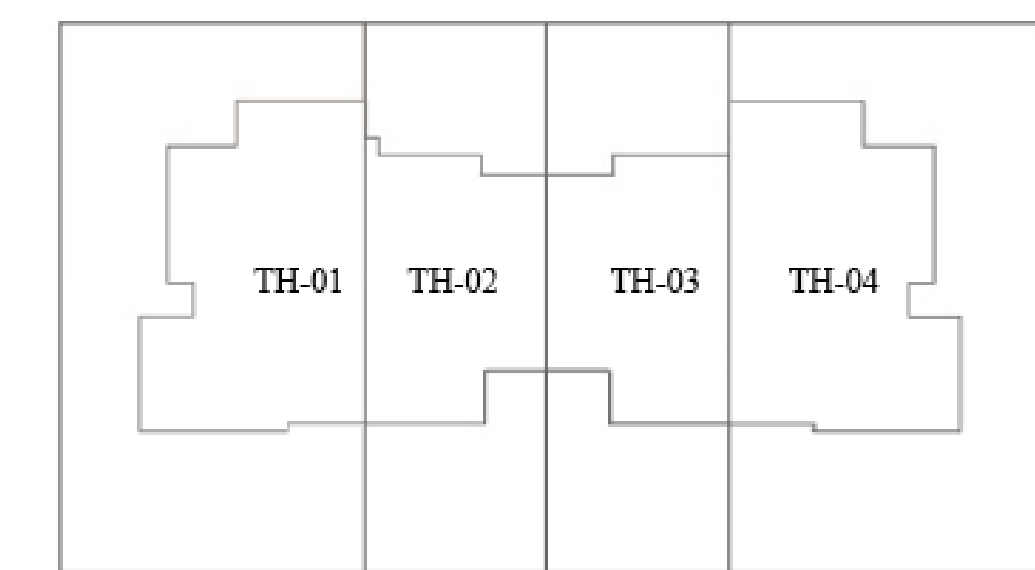

4 PLEX

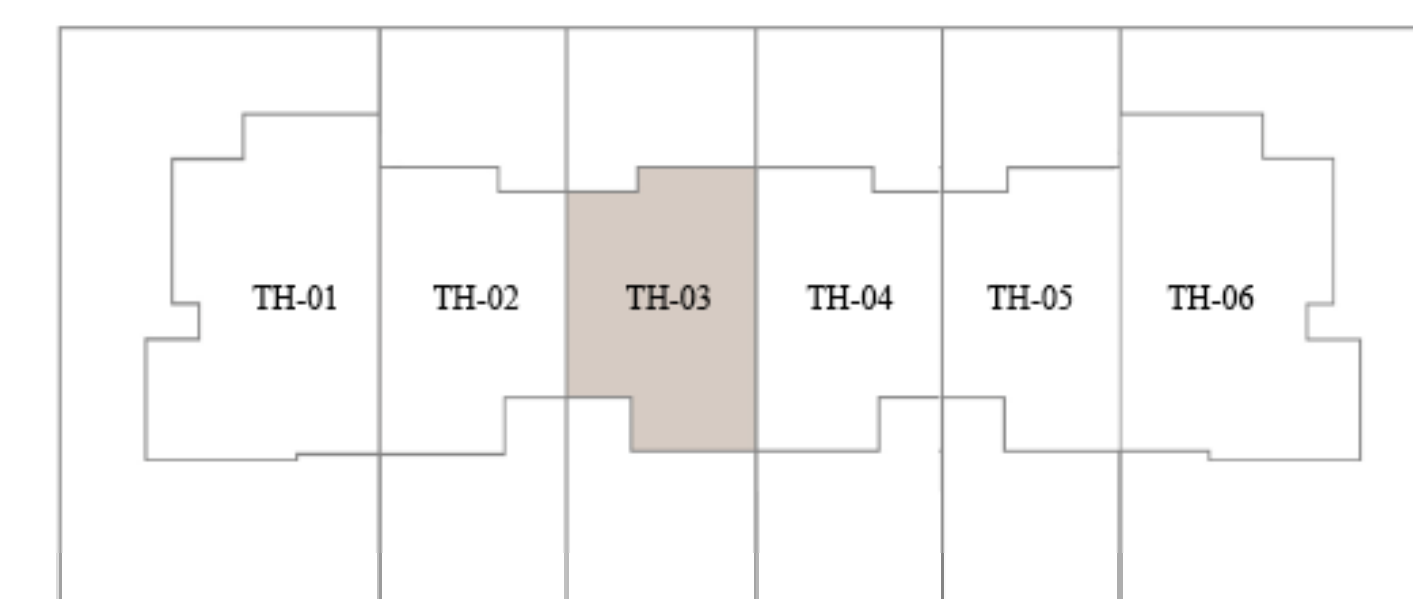

6 PLEX - TH03

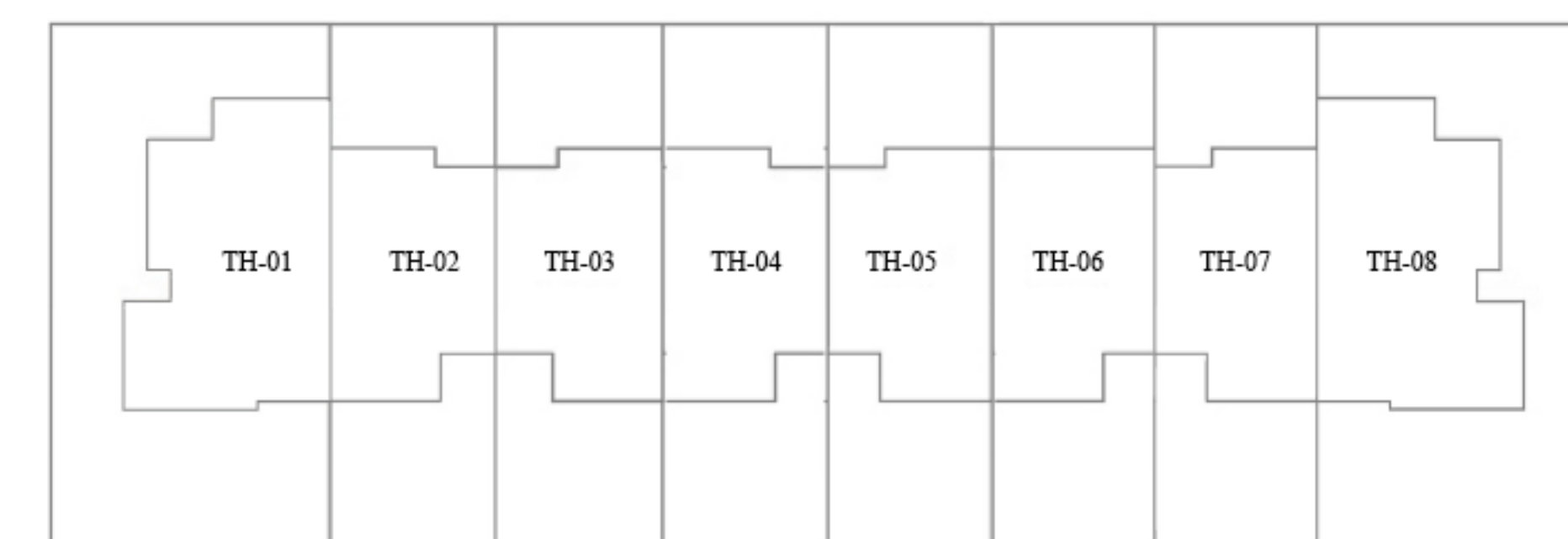

8 PLEX

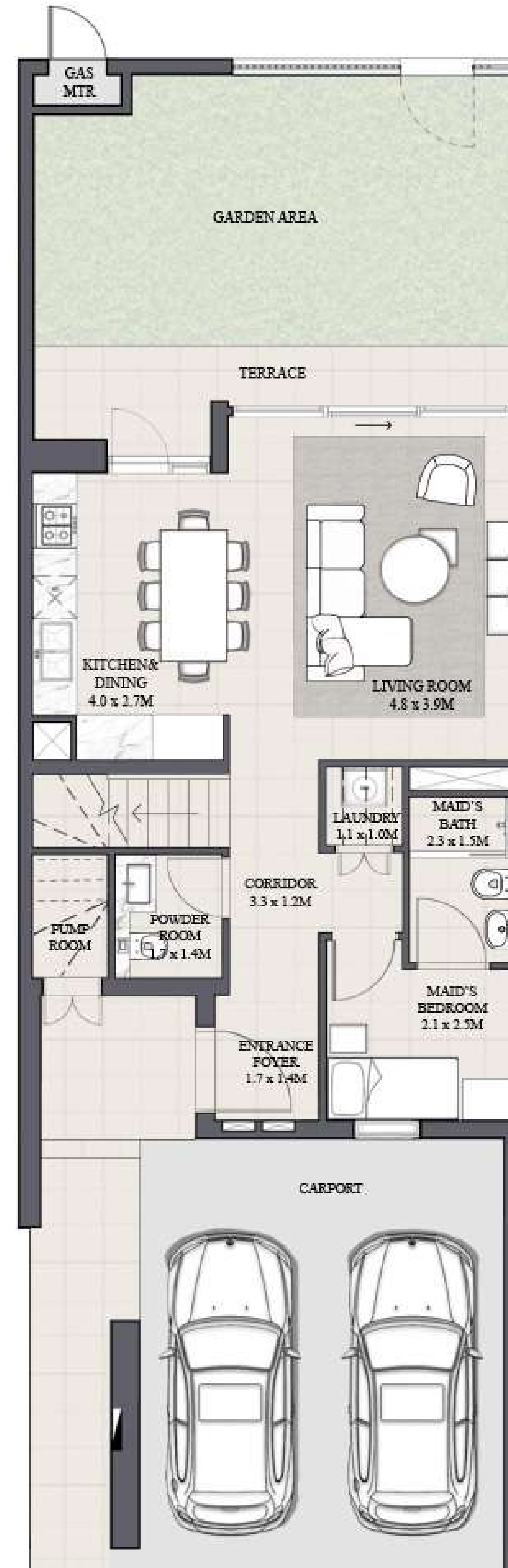

GROUND FLOOR



FIRST FLOOR

FLOOR PLAN 1. All dimensions are in imperial and metric, and measured from finish to finish excluding construction tolerances. 2. All materials, dimensions, and drawings are approximate only. 3. Information is subject to change without notice, at developer's absolute discretion. 4. Actual area may vary from the stated area. 5. Drawings not to scale. 6. All images used are for illustrative purposes only and do not represent the actual size, features, specifications, fittings, and furnishings. 7. The developer reserves the right to make revisions / alterations, at its absolute discretion, without any liability whatsoever.

ANYA

ARABIAN RANCHES III

MODERN TOWNHOUSE 3 BEDROOM 3 M MIRRORED

UNIT	TOTAL AREA	
6 PLEX - TH04	1912.10 SQFT	177.64 SQM

KEY PLAN

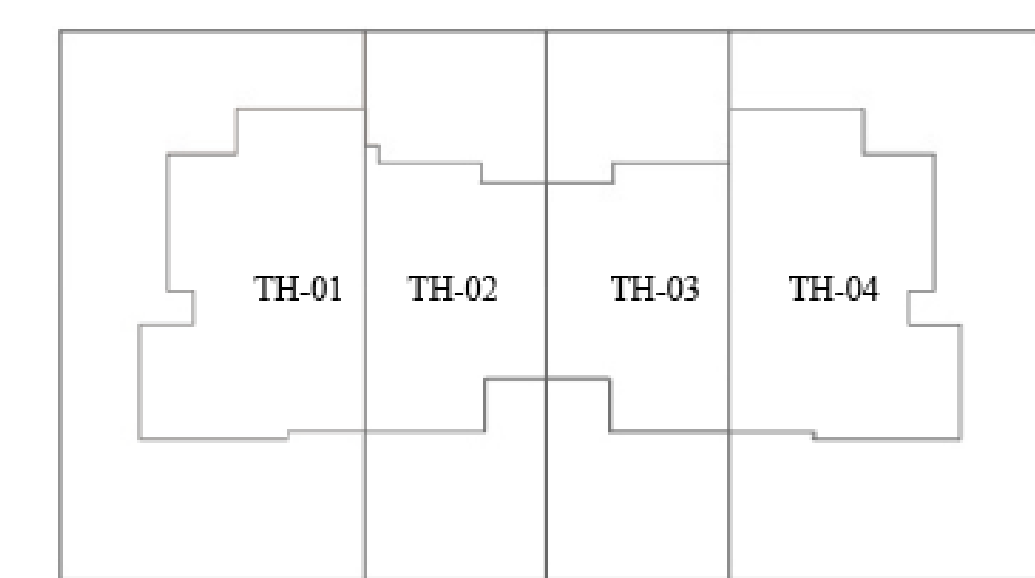

4 PLEX

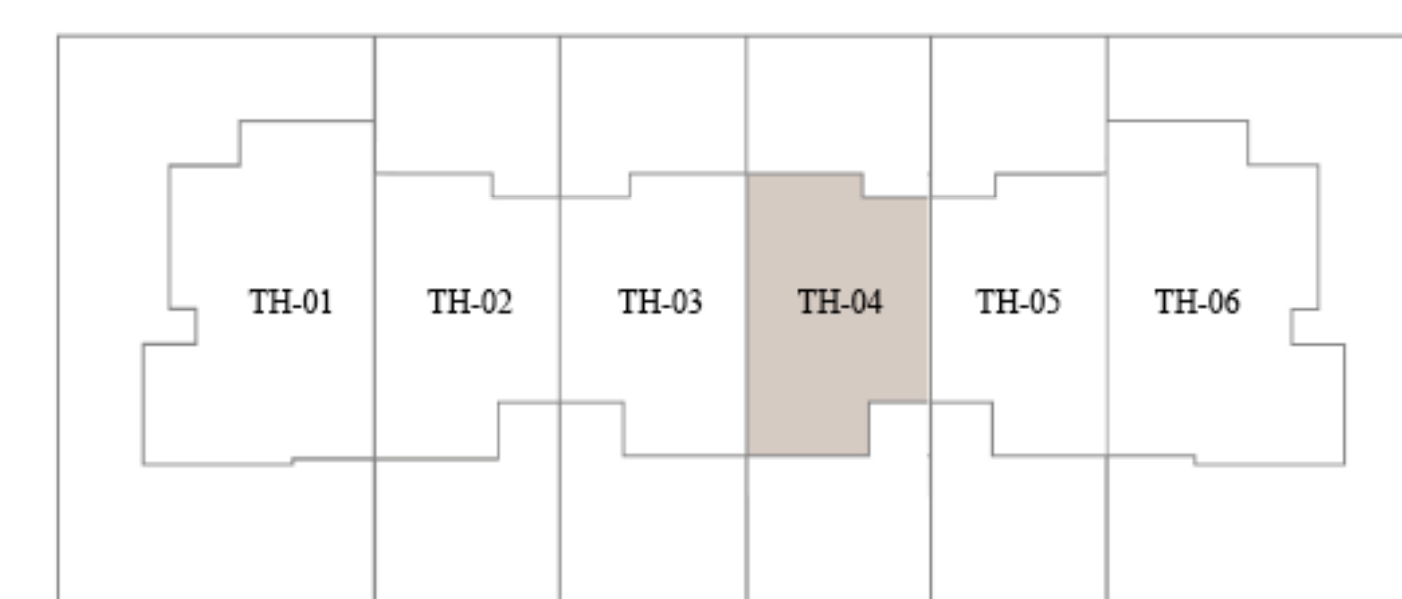

6 PLEX - TH04

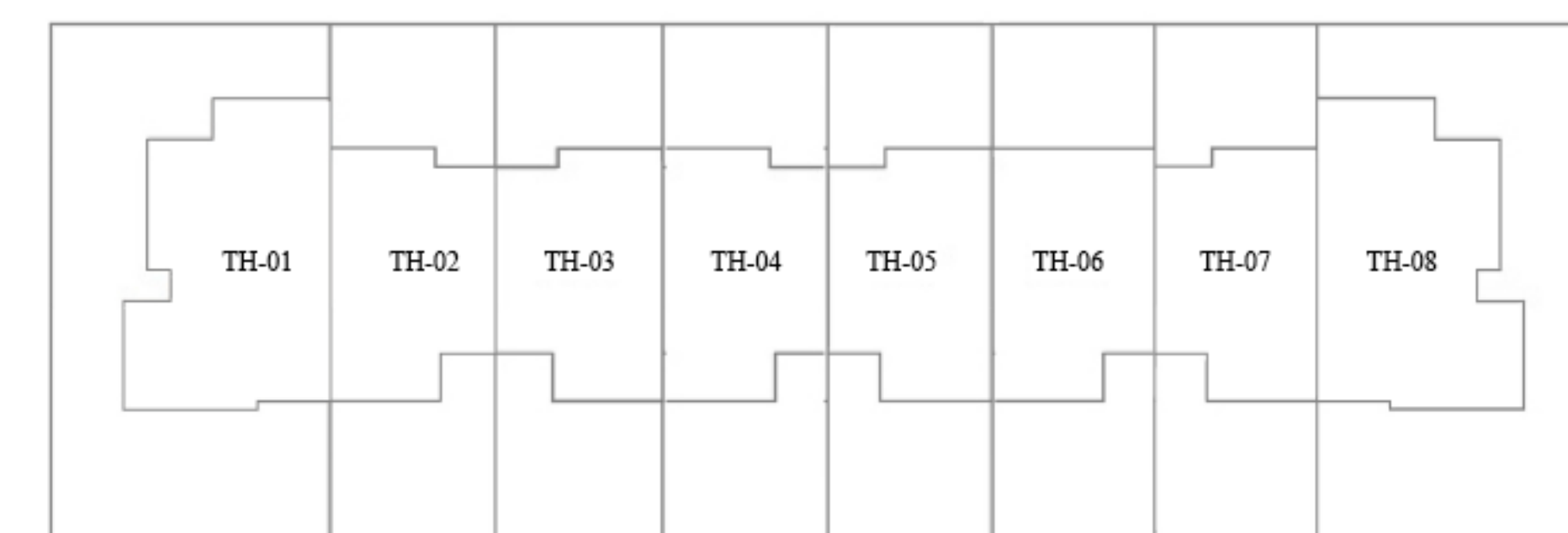

8 PLEX

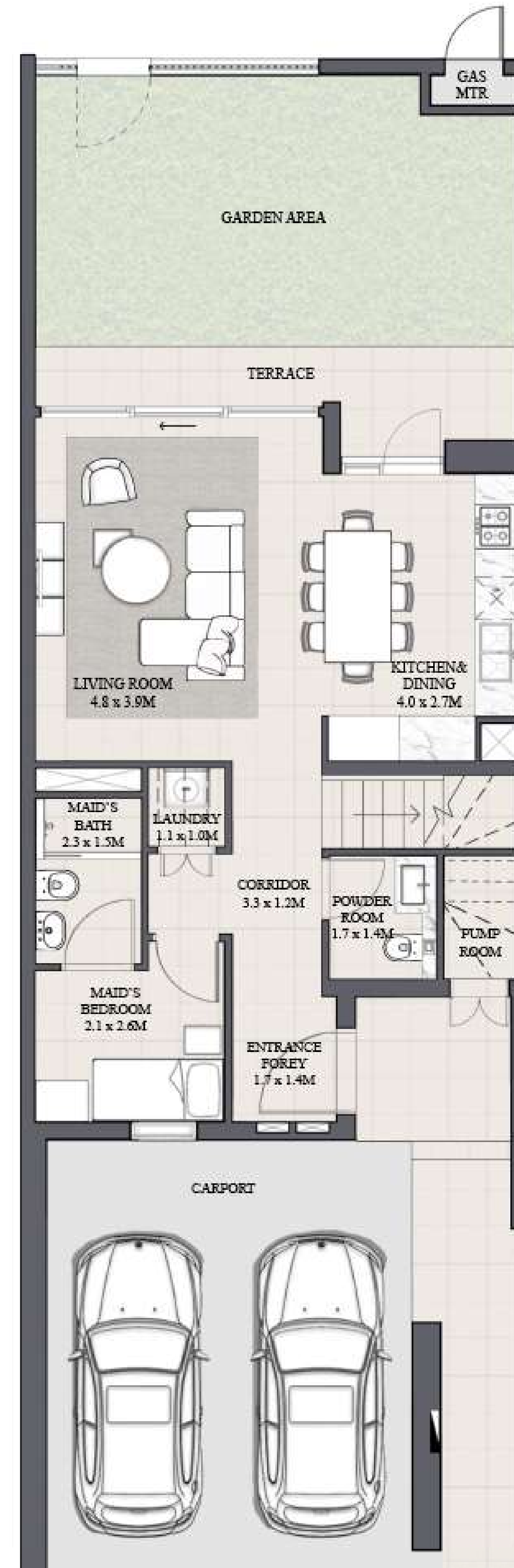

GROUND FLOOR

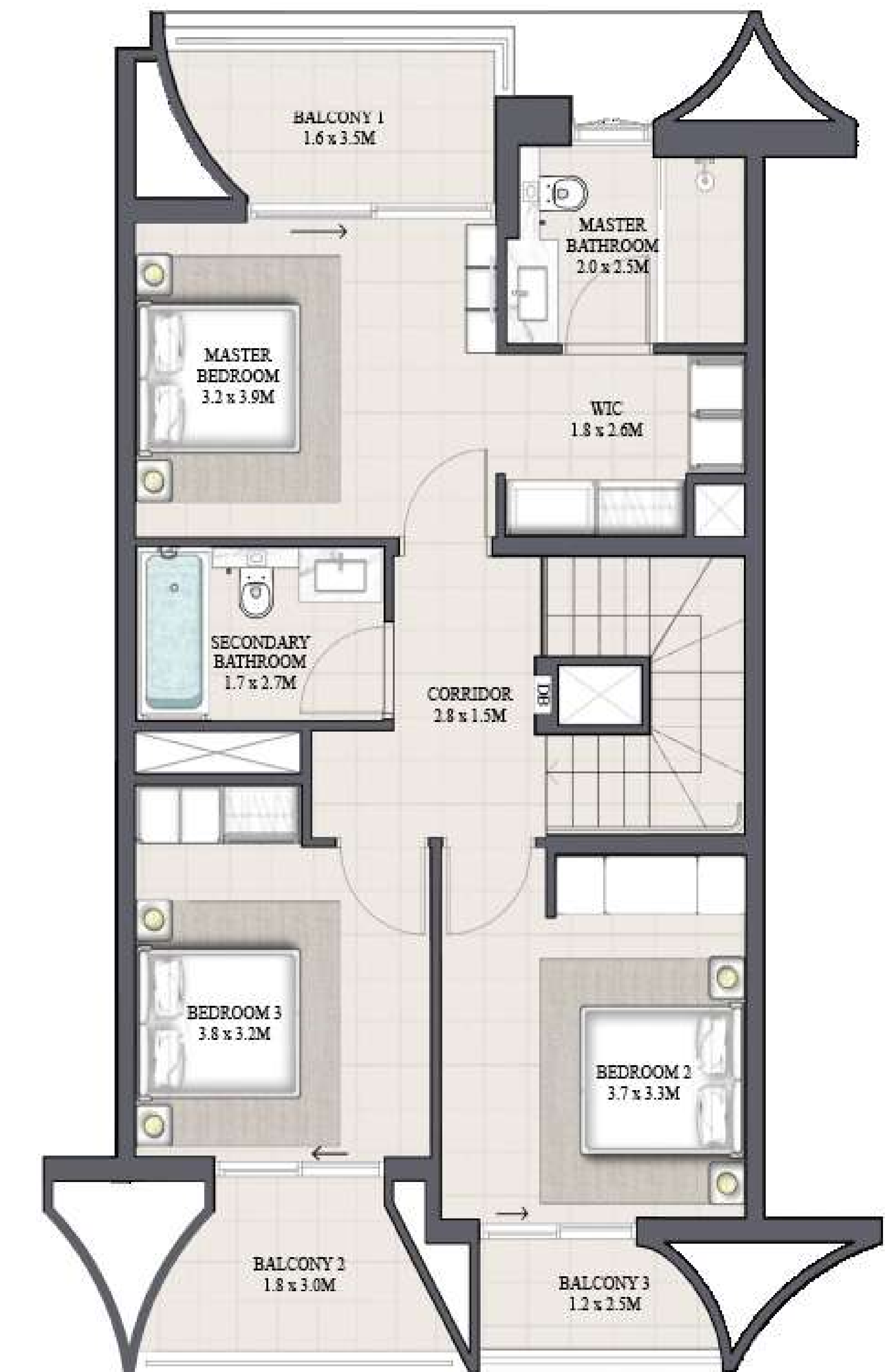

FIRST FLOOR

FLOOR PLAN 1. All dimensions are in imperial and metric, and measured from finish to finish excluding construction tolerances. 2. All materials, dimensions, and drawings are approximate only. 3. Information is subject to change without notice, at developer's absolute discretion. 4. Actual area may vary from the stated area. 5. Drawings not to scale. 6. All images used are for illustrative purposes only and do not represent the actual size, features, specifications, fittings, and furnishings. 7. The developer reserves the right to make revisions / alterations, at its absolute discretion, without any liability whatsoever.

ANYA

ARABIAN RANCHES III

MODERN TOWNHOUSE 3 BEDROOM 4

UNIT	TOTAL AREA	
8 PLEX - TH03	1912.53 SQFT	177.68 SQM

KEY PLAN

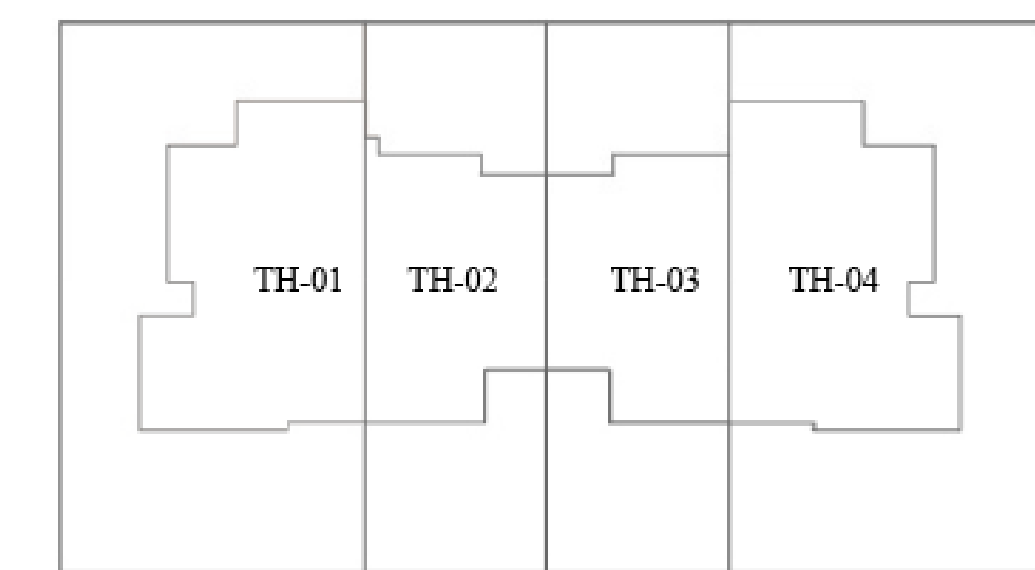

4 PLEX

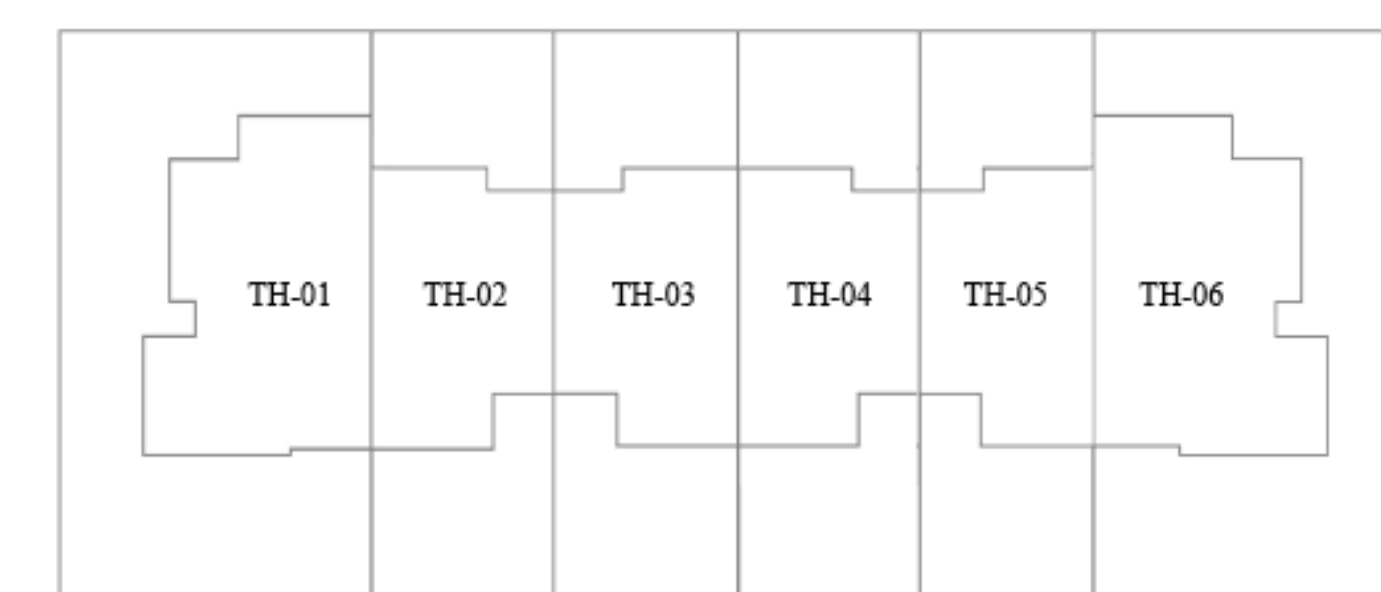

6 PLEX

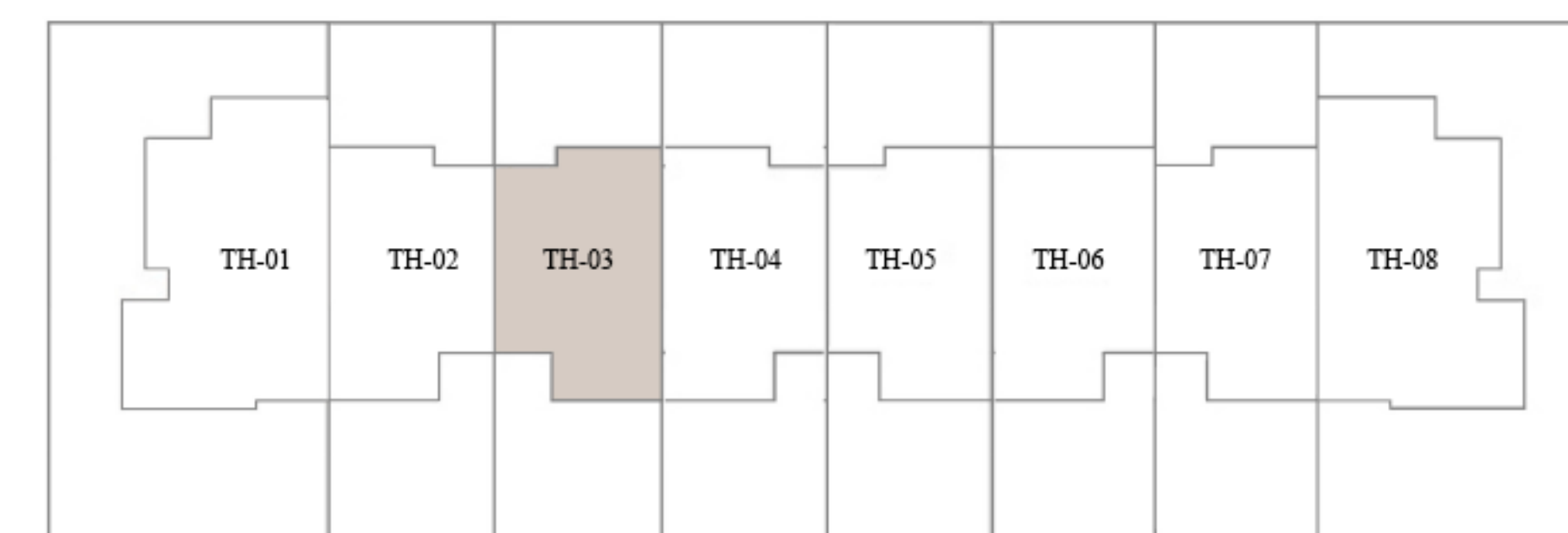

8 PLEX - TH03

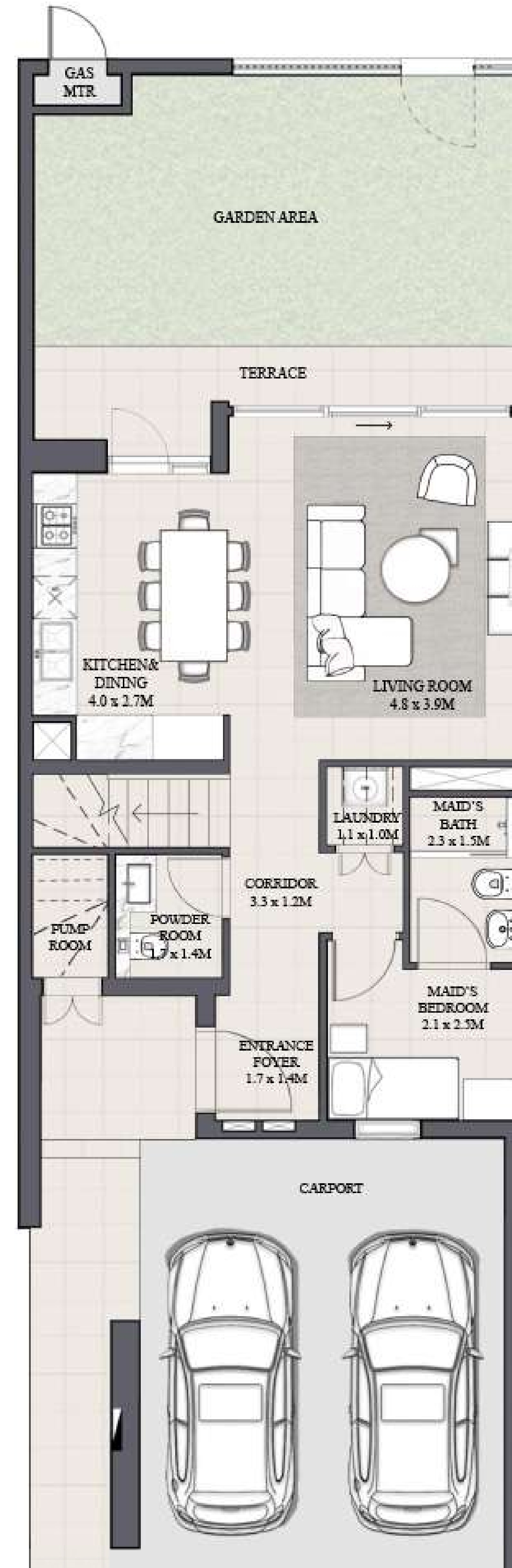

GROUND FLOOR



FIRST FLOOR

FLOOR PLAN 1. All dimensions are in imperial and metric, and measured from finish to finish excluding construction tolerances. 2. All materials, dimensions, and drawings are approximate only. 3. Information is subject to change without notice, at developer's absolute discretion. 4. Actual area may vary from the stated area. 5. Drawings not to scale. 6. All images used are for illustrative purposes only and do not represent the actual size, features, specifications, fittings, and furnishings. 7. The developer reserves the right to make revisions / alterations, at its absolute discretion, without any liability whatsoever.

ANYA

ARABIAN RANCHES III

MODERN TOWNHOUSE 3 BEDROOM 5

UNIT	TOTAL AREA	
8 PLEX - TH04	1907.69 SQFT	177.23 SQM

KEY PLAN

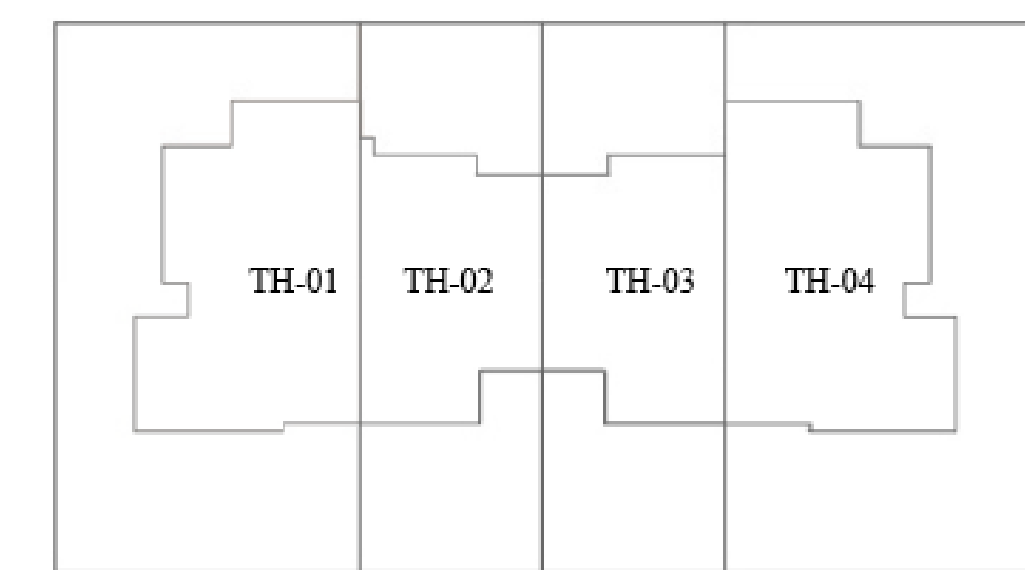

4 PLEX

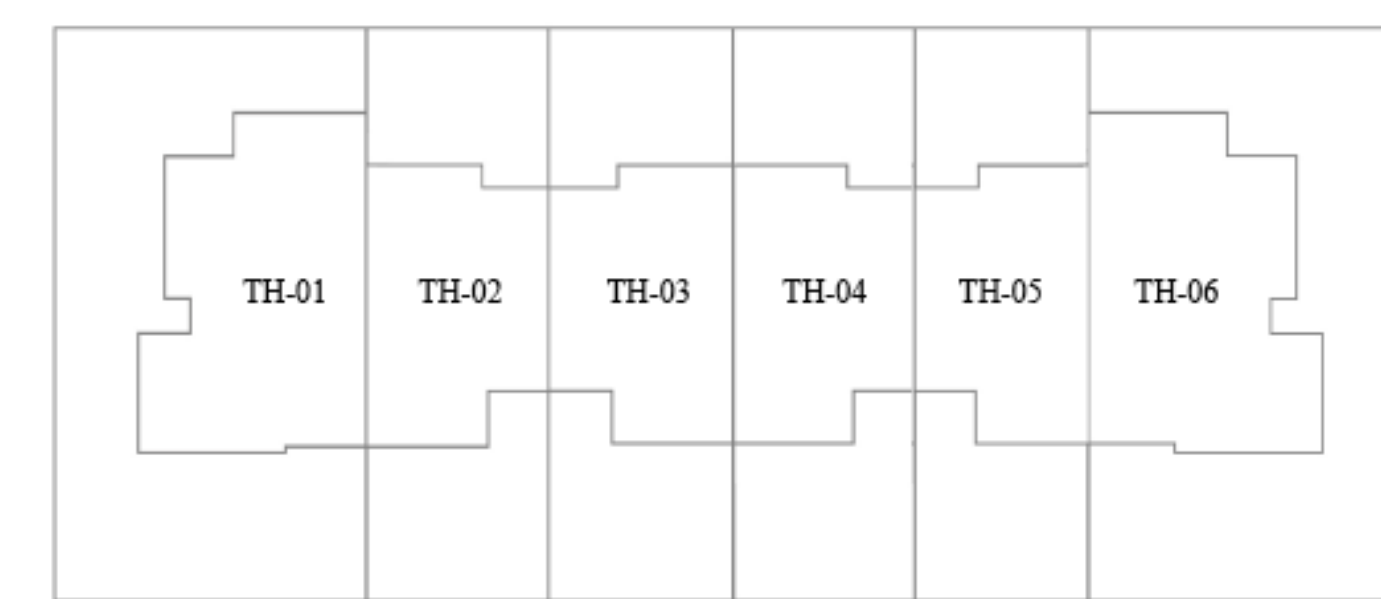

6 PLEX

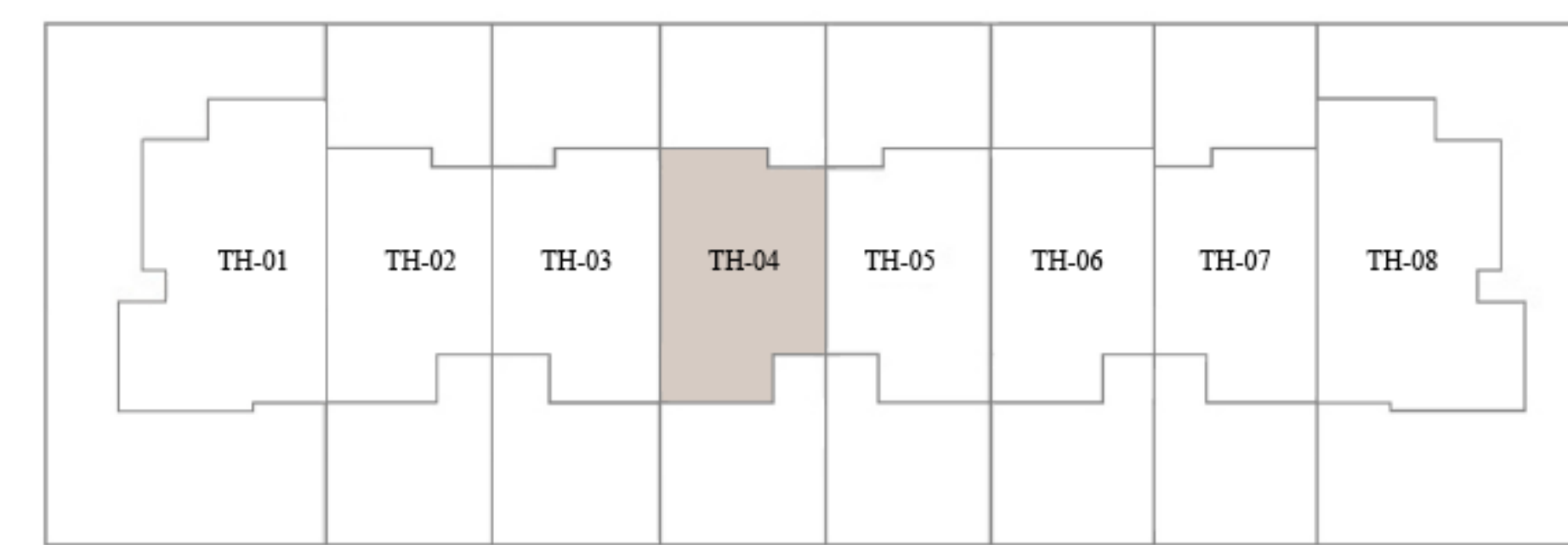

8 PLEX - TH04

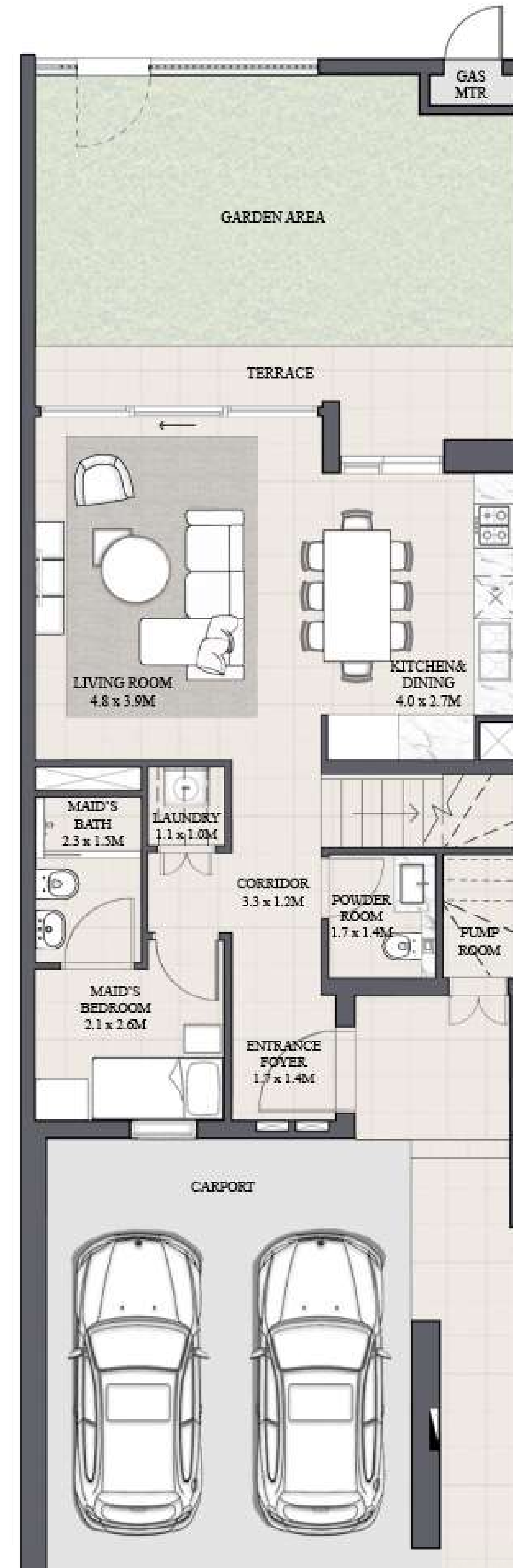

GROUND FLOOR

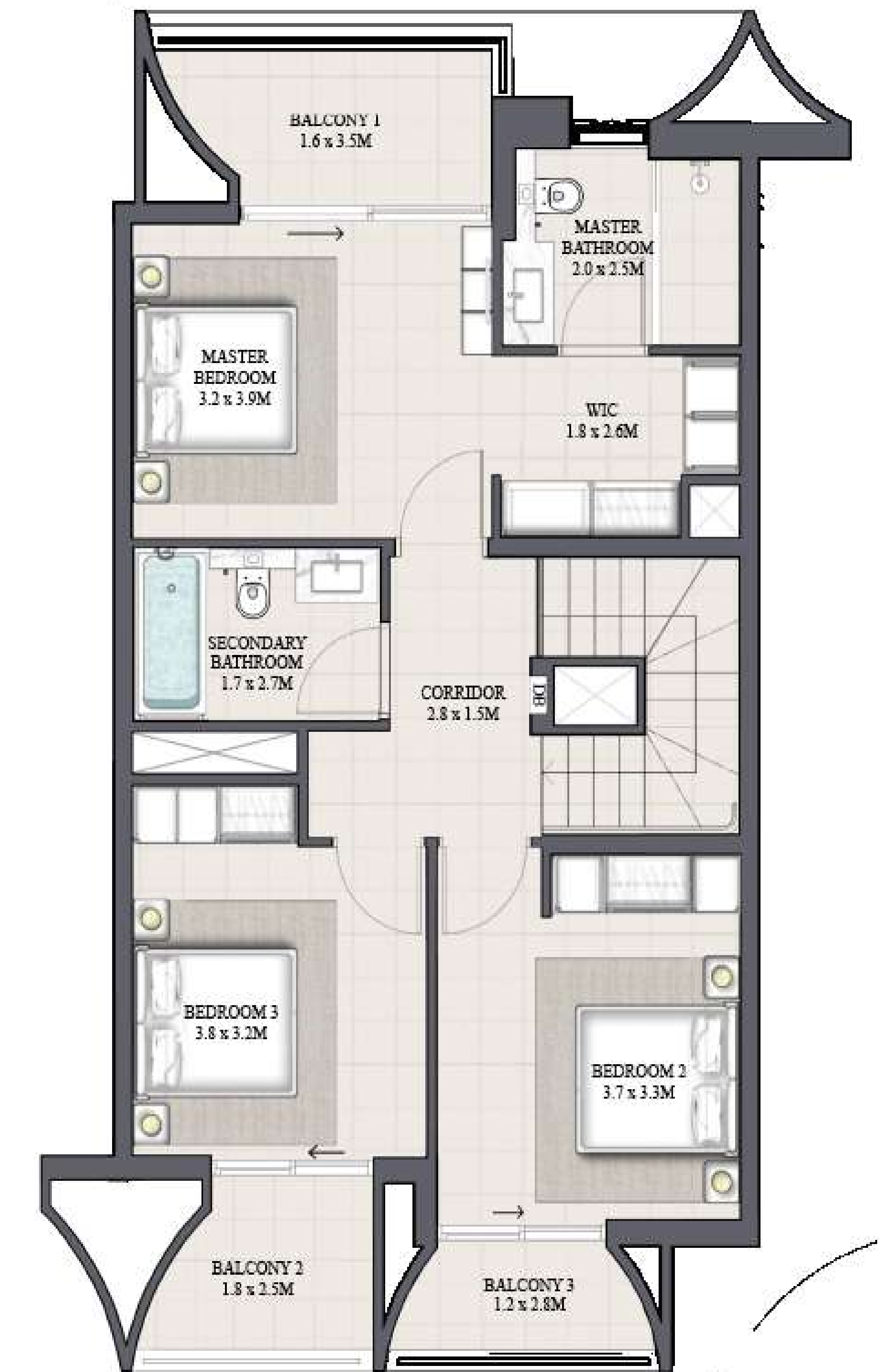

FIRST FLOOR

FLOOR PLAN 1. All dimensions are in imperial and metric, and measured from finish to finish excluding construction tolerances. 2. All materials, dimensions, and drawings are approximate only. 3. Information is subject to change without notice, at developer's absolute discretion. 4. Actual area may vary from the stated area. 5. Drawings not to scale. 6. All images used are for illustrative purposes only and do not represent the actual size, features, specifications, fittings, and furnishings. 7. The developer reserves the right to make revisions / alterations, at its absolute discretion, without any liability whatsoever.

ANYA

ARABIAN RANCHES III

MODERN TOWNHOUSE 3 BEDROOM 5 M MIRRORED

UNIT	TOTAL AREA
8 PLEX - TH05	1907.69 SQFT 177.23 SQM

KEY PLAN

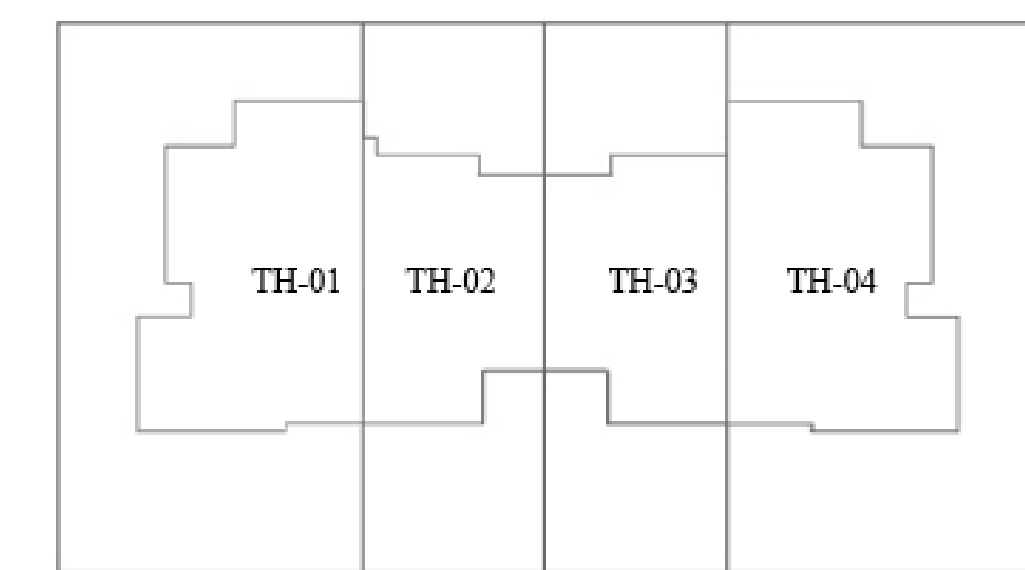

4 PLEX

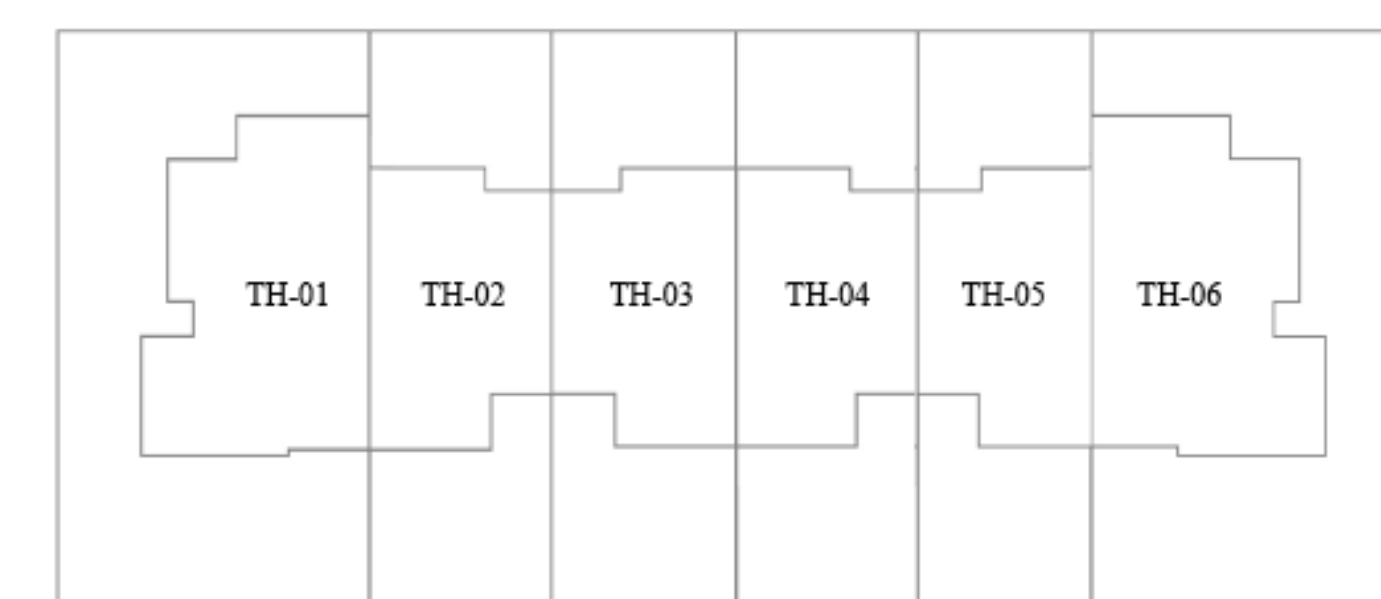

6 PLEX

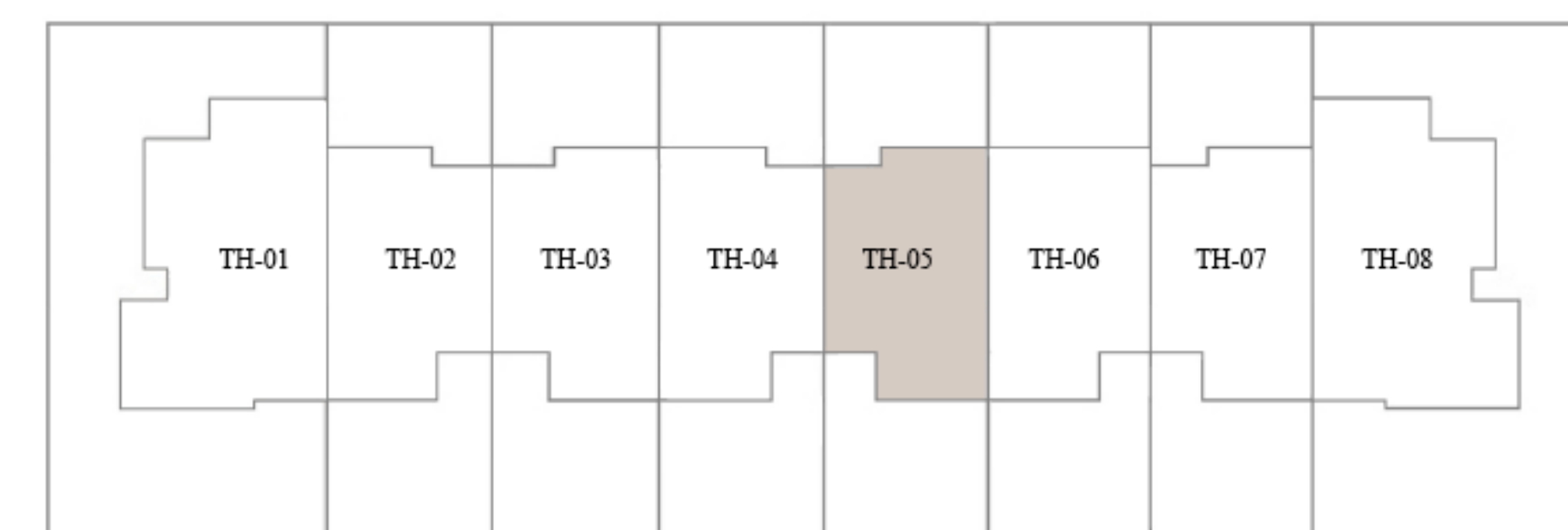

8 PLEX - TH05

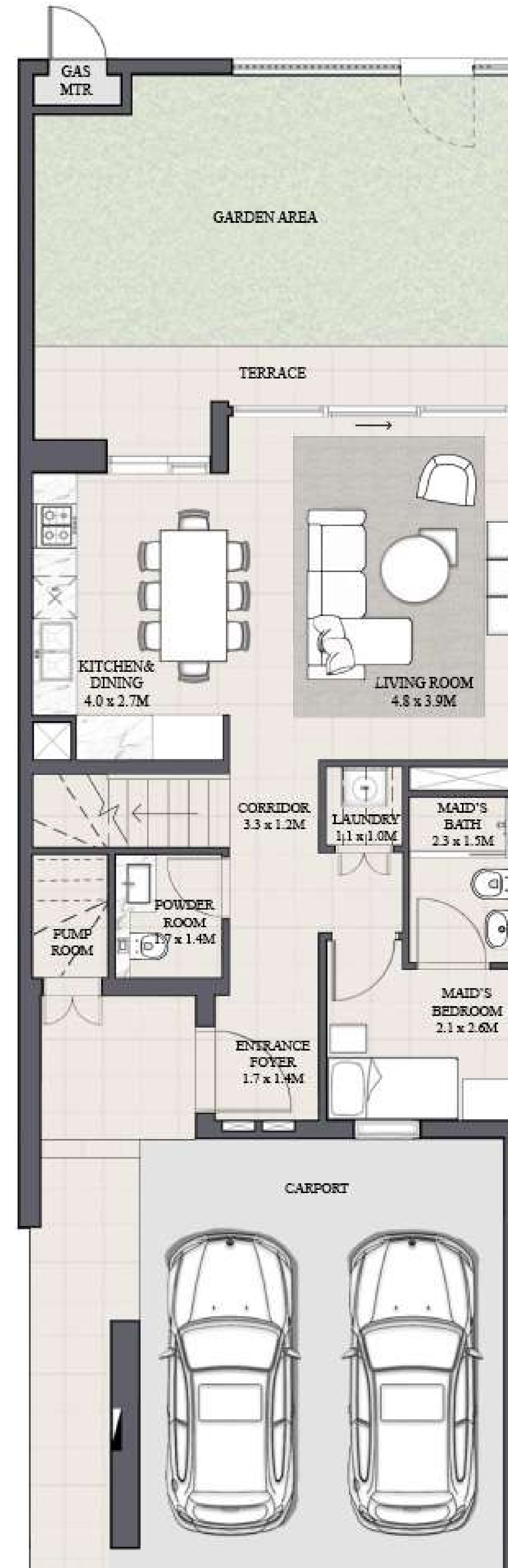

GROUND FLOOR



FIRST FLOOR

FLOOR PLAN 1. All dimensions are in imperial and metric, and measured from finish to finish excluding construction tolerances. 2. All materials, dimensions, and drawings are approximate only. 3. Information is subject to change without notice, at developer's absolute discretion. 4. Actual area may vary from the stated area. 5. Drawings not to scale. 6. All images used are for illustrative purposes only and do not represent the actual size, features, specifications, fittings, and furnishings. 7. The developer reserves the right to make revisions / alterations, at its absolute discretion, without any liability whatsoever.

ANYA

ARABIAN RANCHES III

CLASSIC TOWNHOUSE 4 BEDROOM 1

UNIT	TOTAL AREA	
4 PLEX - TH01		
6 PLEX - TH01	2373.33 SQFT	220.49 SQM
8 PLEX - TH01		

KEY PLAN

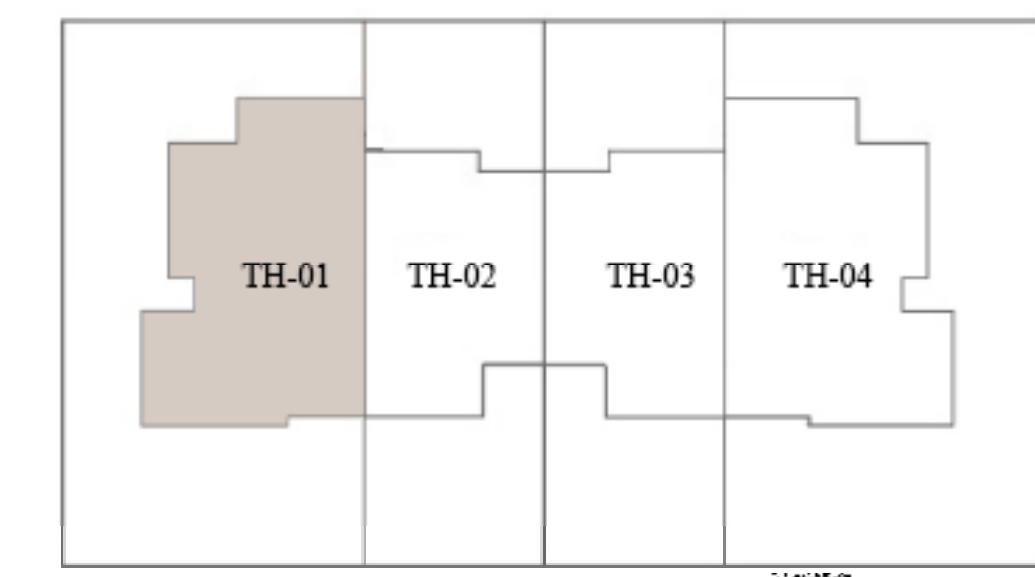

4 PLEX - TH01

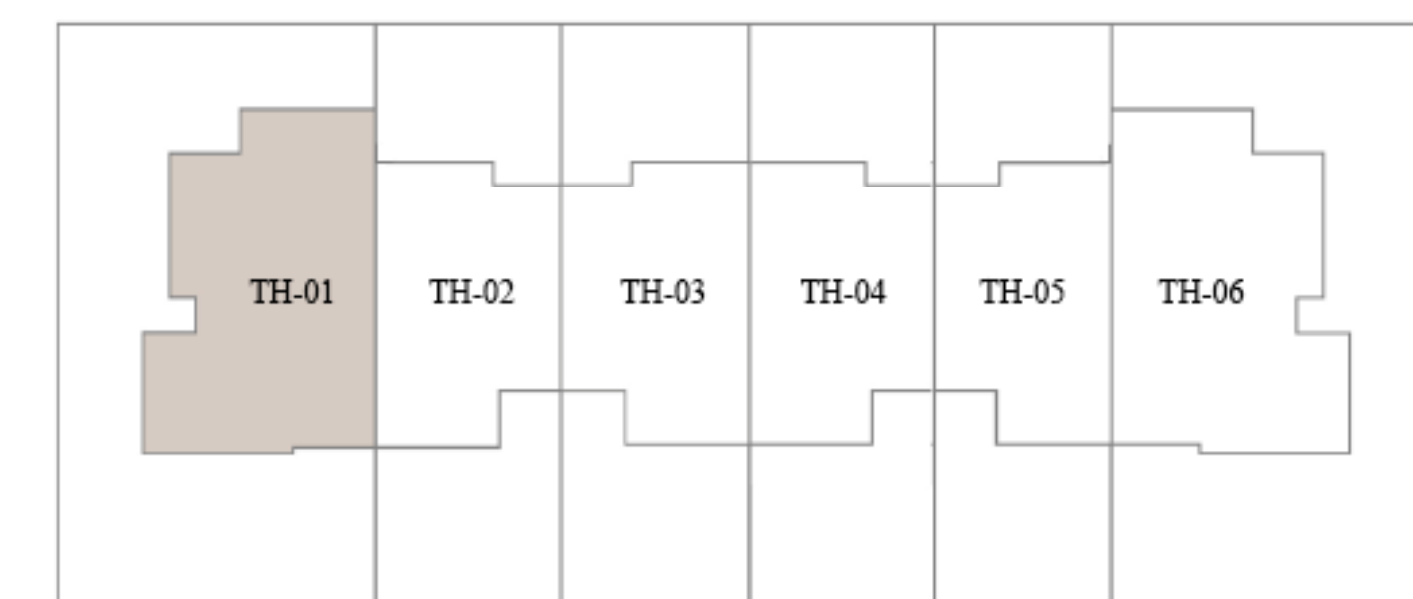

6 PLEX - TH01

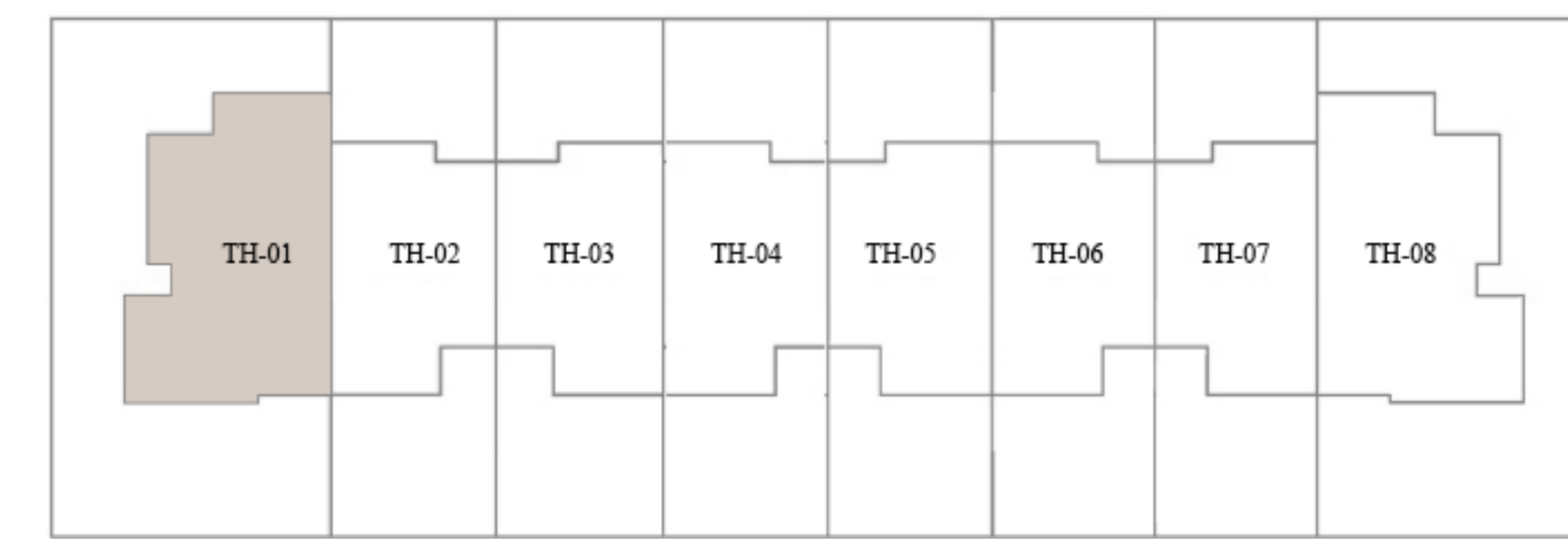

8 PLEX - TH01



GROUND FLOOR



FIRST FLOOR

FLOOR PLAN 1. All dimensions are in imperial and metric, and measured from finish to finish excluding construction tolerances. 2. All materials, dimensions, and drawings are approximate only. 3. Information is subject to change without notice, at developer's absolute discretion. 4. Actual area may vary from the stated area. 5. Drawings not to scale. 6. All images used are for illustrative purposes only and do not represent the actual size, features, specifications, fittings, and furnishings. 7. The developer reserves the right to make revisions / alterations, at it's absolute discretion, without any liability whatsoever.

ANYA

ARABIAN RANCHES III

CLASSIC TOWNHOUSE 4 BEDROOM 1 M MIRRORED

UNIT	TOTAL AREA	
4 PLEX - TH04		
6 PLEX - TH06	2373.33 SQFT	220.49 SQM
8 PLEX - TH08		

KEY PLAN

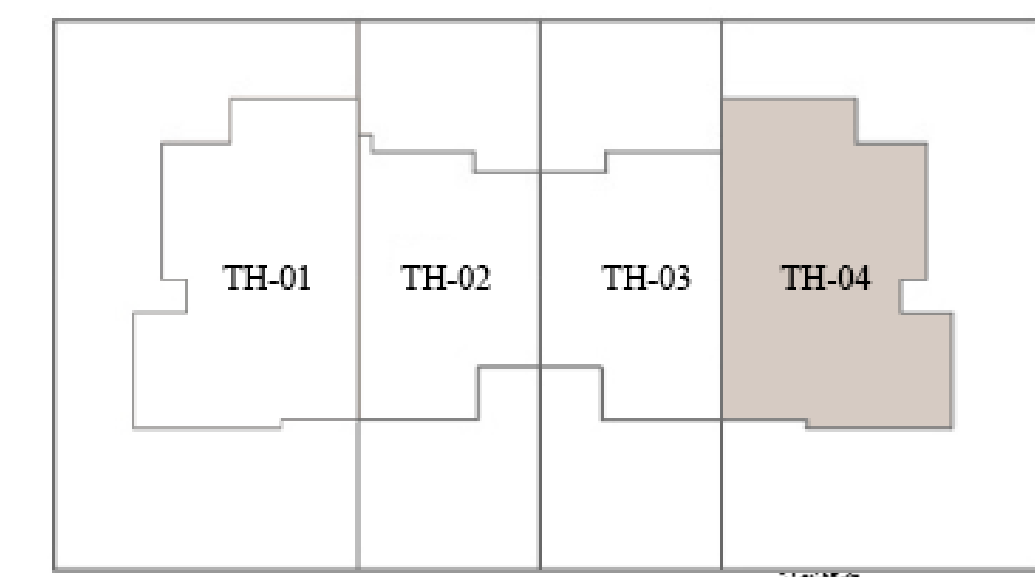

4 PLEX - TH04

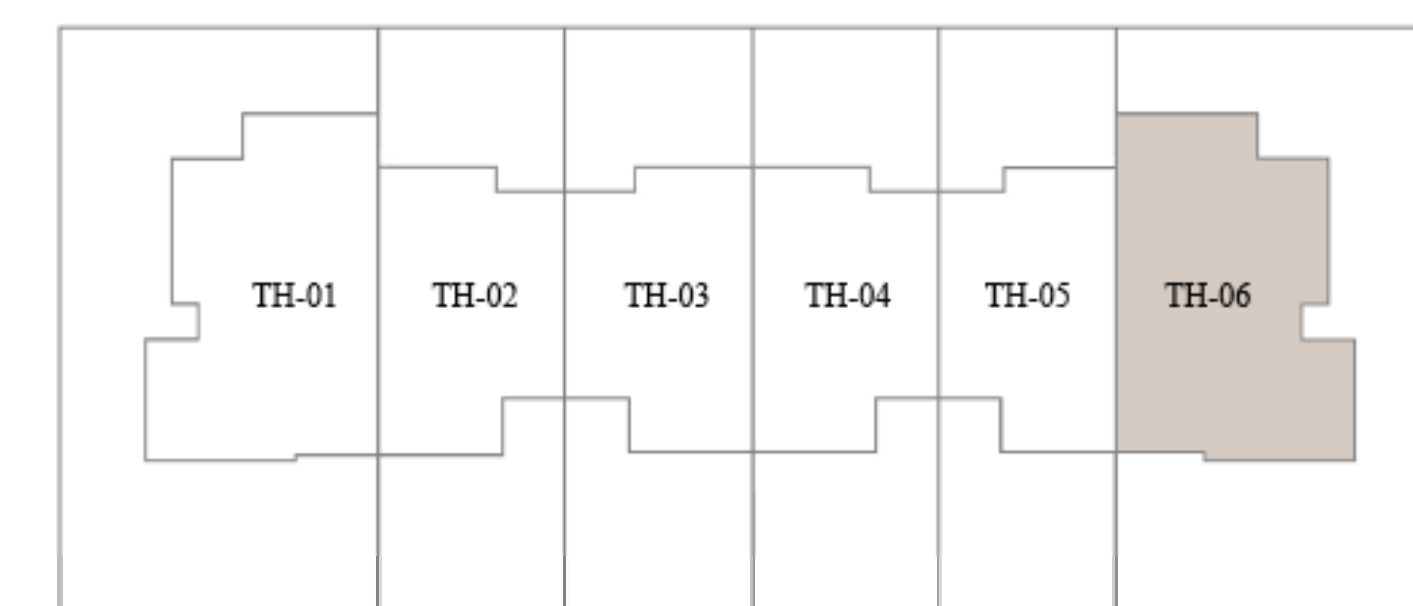

6 PLEX - TH06

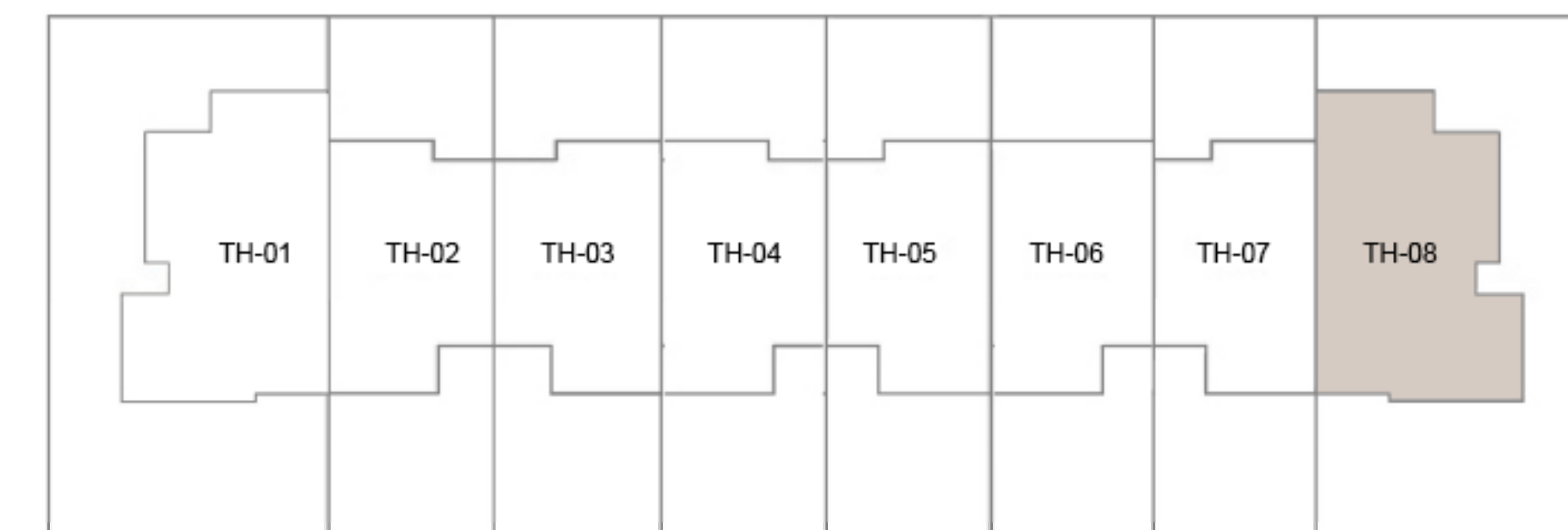

8 PLEX - TH08



GROUND FLOOR

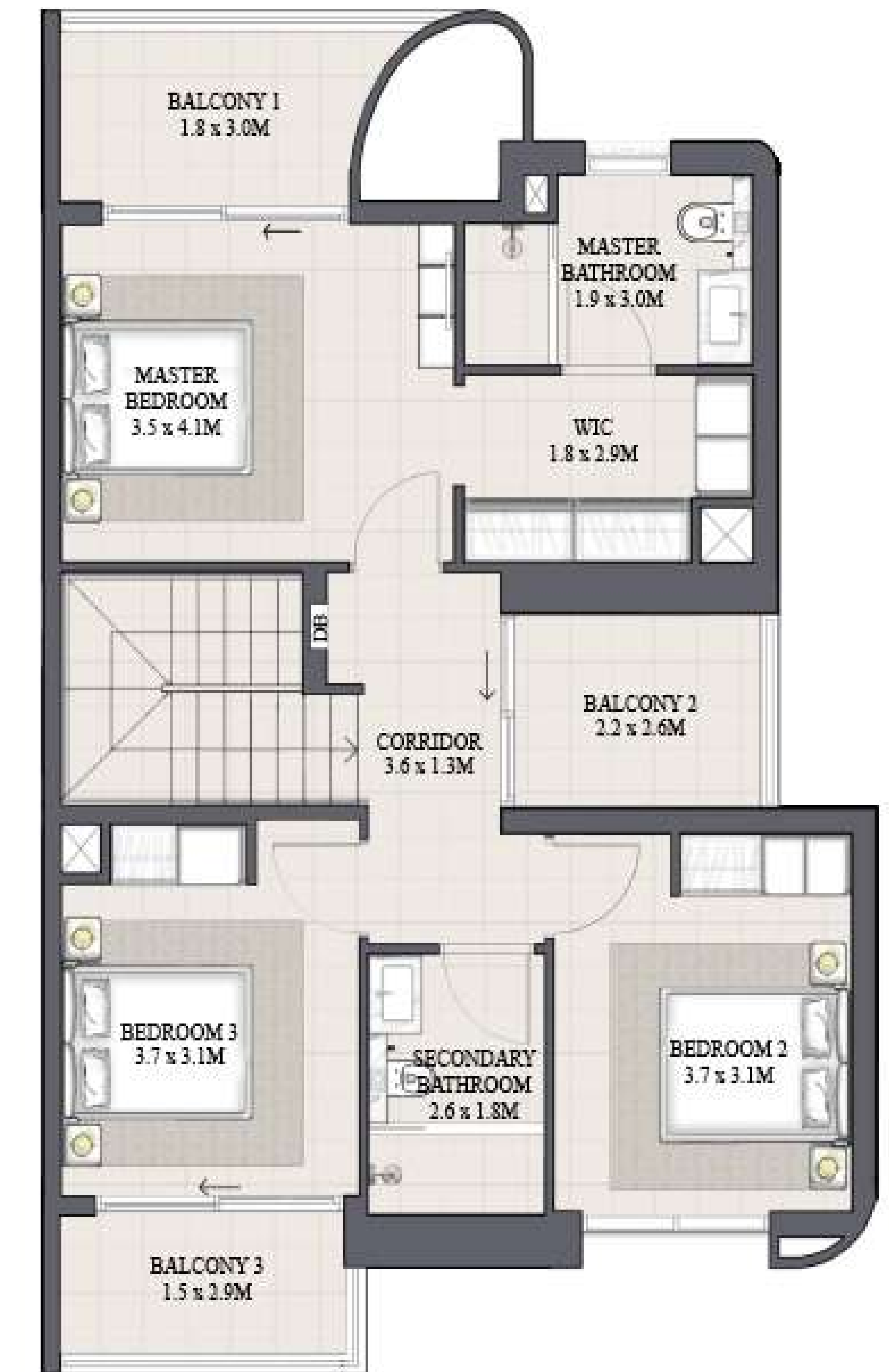

FIRST FLOOR

FLOOR PLAN 1. All dimensions are in imperial and metric, and measured from finish to finish excluding construction tolerances. 2. All materials, dimensions, and drawings are approximate only. 3. Information is subject to change without notice, at developer's absolute discretion. 4. Actual area may vary from the stated area. 5. Drawings not to scale. 6. All images used are for illustrative purposes only and do not represent the actual size, features, specifications, fittings, and furnishings. 7. The developer reserves the right to make revisions / alterations, at it's absolute discretion, without any liability whatsoever.

ANYA

ARABIAN RANCHES III

CLASSIC TOWNHOUSE 3 BEDROOM 1

UNIT	TOTAL AREA	
4 PLEX - TH02		
6 PLEX - TH02	1990.14 SQFT	184.89 SQM
8 PLEX - TH02		
6 PLEX - TH04		
8 PLEX - TH04	1988.52 SQFT	184.74 SQM
8 PLEX - TH06		

KEY PLAN

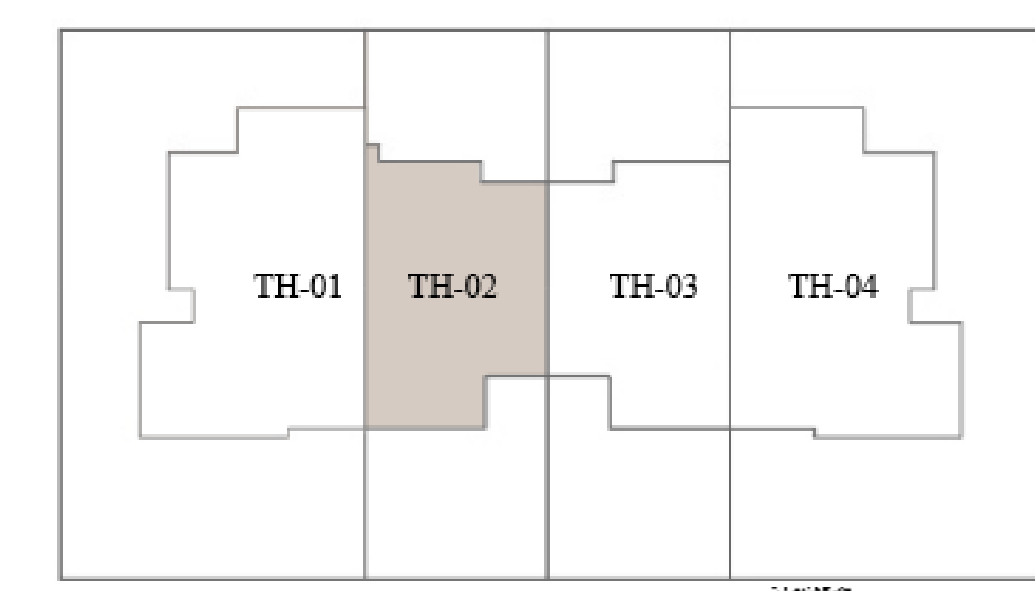

4 PLEX - TH02

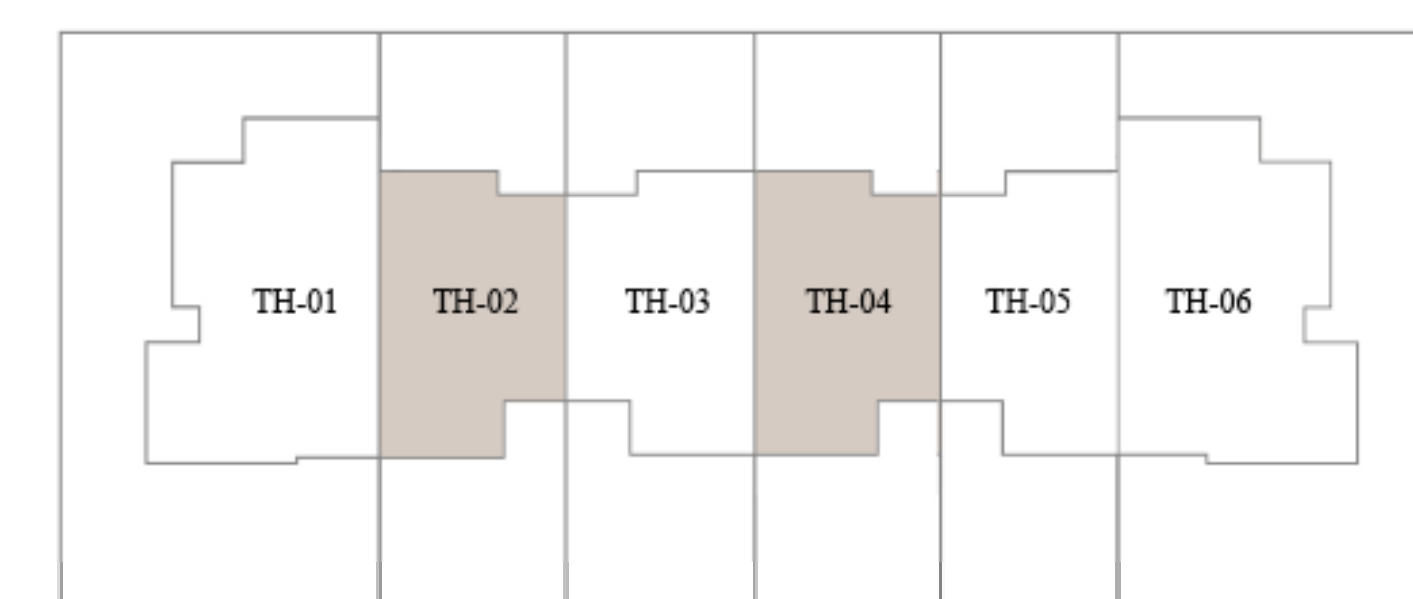

6 PLEX - TH02, TH04

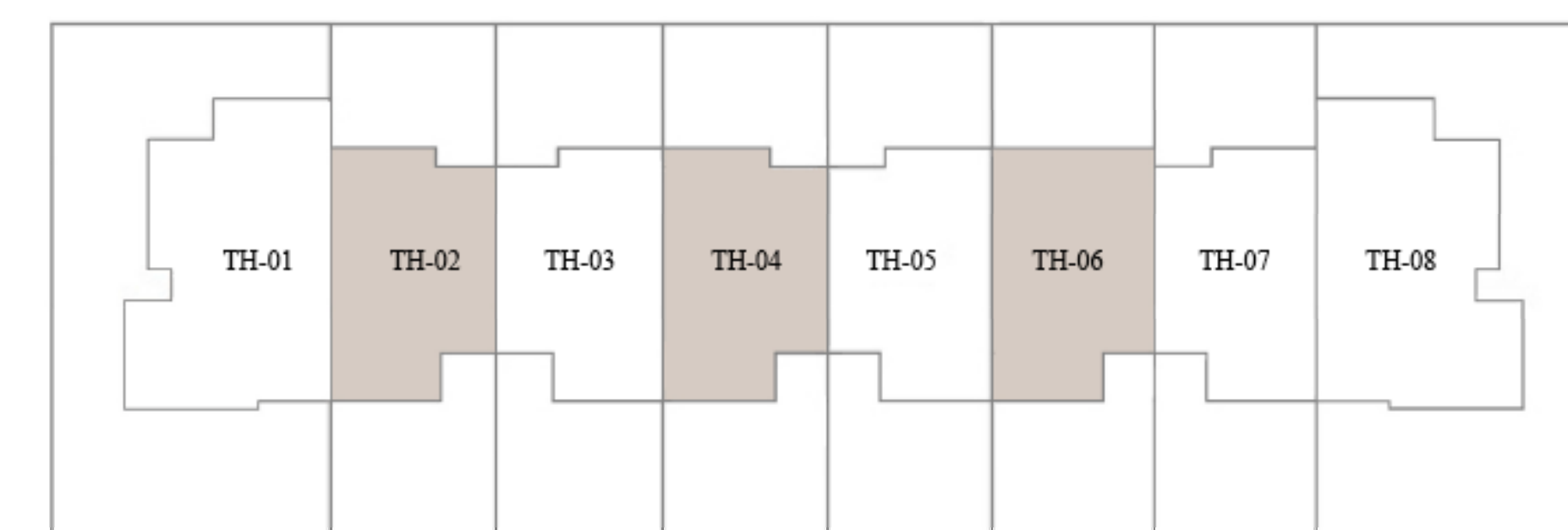

8 PLEX - TH02, TH04, TH06



GROUND FLOOR



FIRST FLOOR

FLOOR PLAN 1. All dimensions are in imperial and metric, and measured from finish to finish excluding construction tolerances. 2. All materials, dimensions, and drawings are approximate only. 3. Information is subject to change without notice, at developer's absolute discretion. 4. Actual area may vary from the stated area. 5. Drawings not to scale. 6. All images used are for illustrative purposes only and do not represent the actual size, features, specifications, fittings, and furnishings. 7. The developer reserves the right to make revisions / alterations, at it's absolute discretion, without any liability whatsoever.

ANYA

ARABIAN RANCHES III

CLASSIC TOWNHOUSE 3 BEDROOM 1 M MIRRORED

UNIT	TOTAL AREA	
4 PLEX - TH03	1990.14 SQFT	184.89 SQM
6 PLEX - TH03	1988.52 SQFT	184.74 SQM
6 PLEX - TH05	1990.14 SQFT	184.89 SQM
8 PLEX - TH03	1988.52 SQFT	184.74 SQM
8 PLEX - TH05	1988.52 SQFT	184.74 SQM
8 PLEX - TH07	1990.14 SQFT	184.89 SQM

KEY PLAN

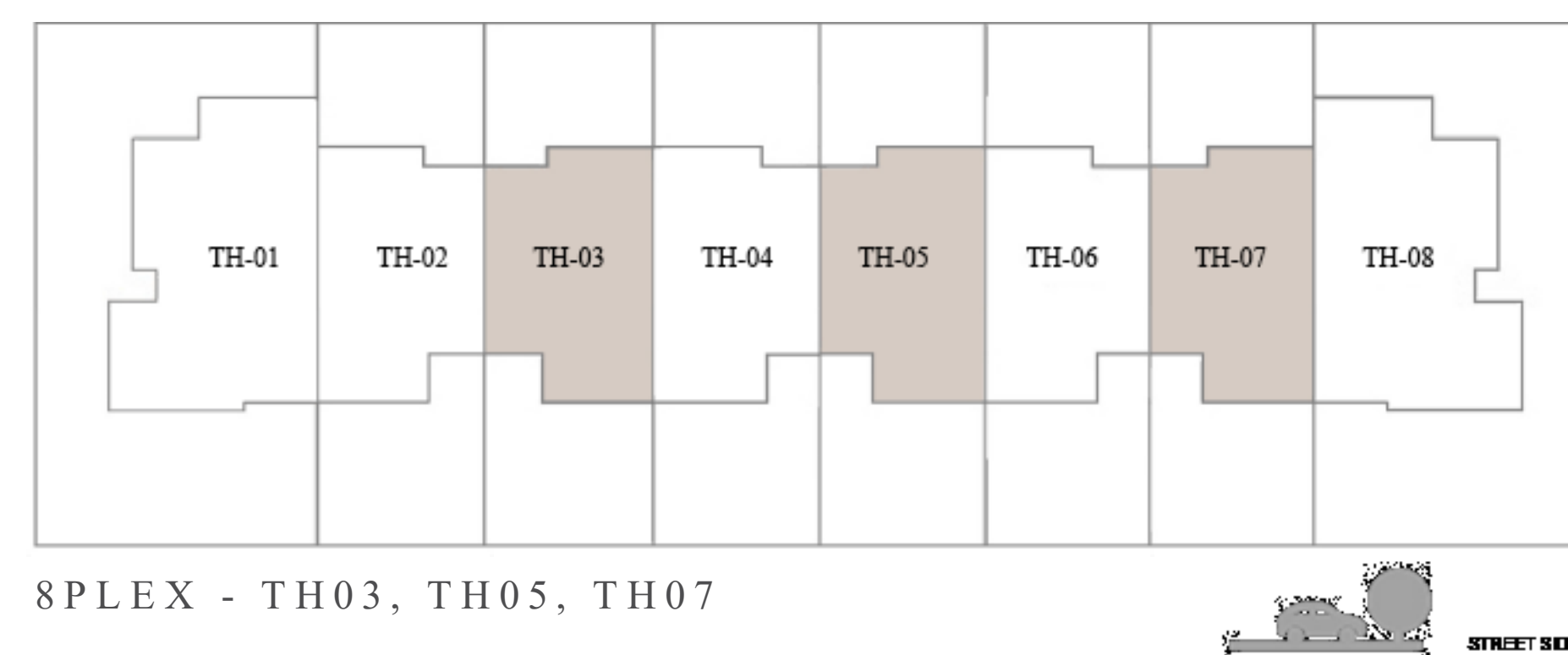
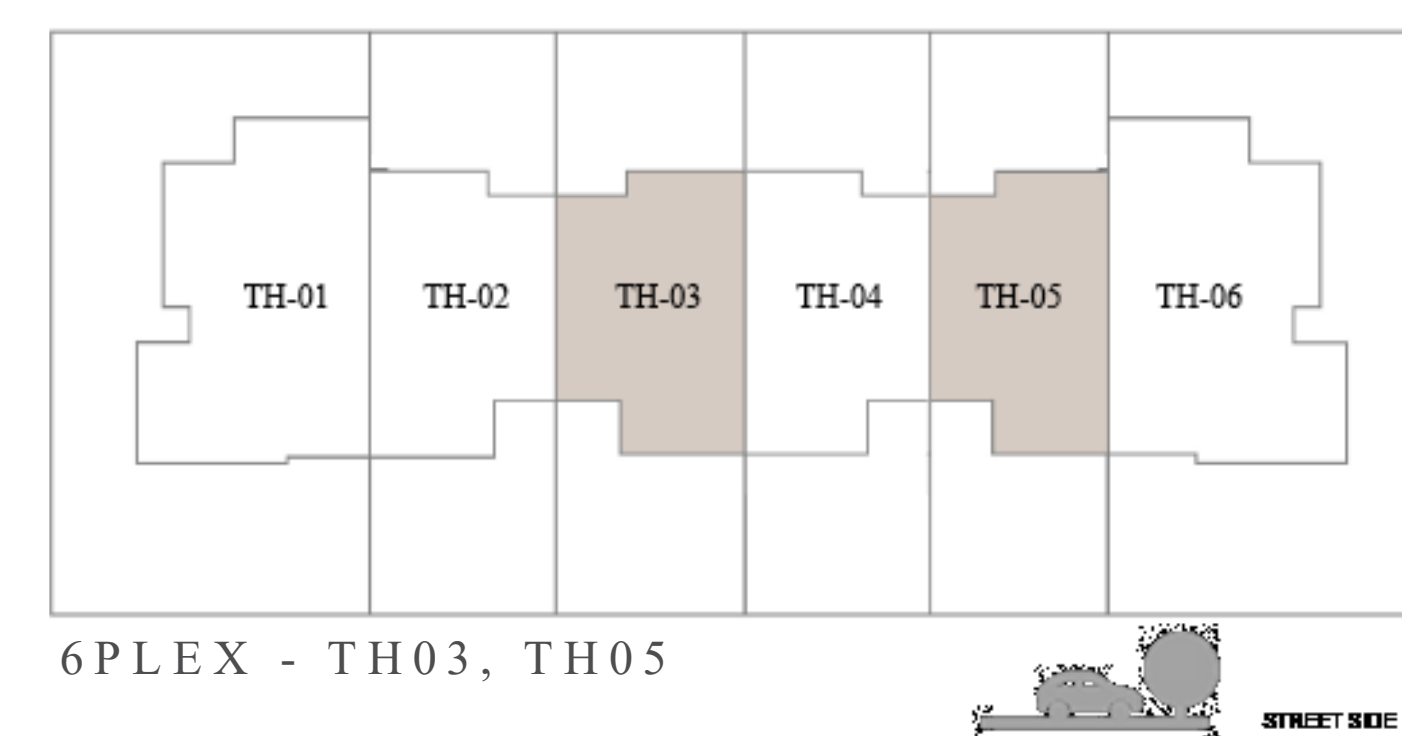
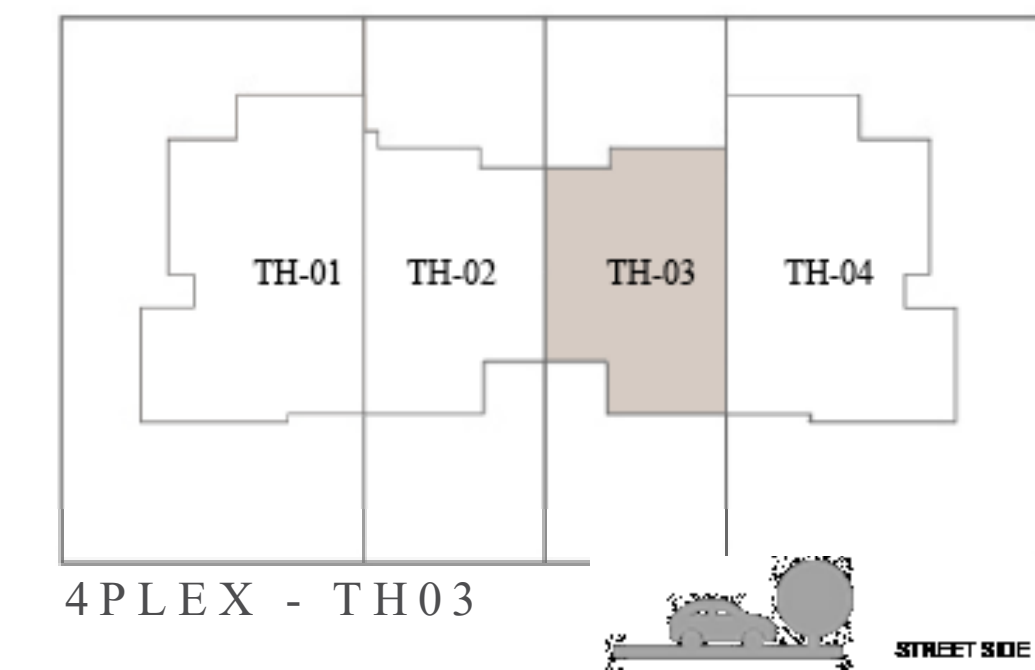

GROUND FLOOR



FIRST FLOOR

FLOOR PLAN 1. All dimensions are in imperial and metric, and measured from finish to finish excluding construction tolerances. 2. All materials, dimensions, and drawings are approximate only. 3. Information is subject to change without notice, at developer's absolute discretion. 4. Actual area may vary from the stated area. 5. Drawings not to scale. 6. All images used are for illustrative purposes only and do not represent the actual size, features, specifications, fittings, and furnishings. 7. The developer reserves the right to make revisions / alterations, at its absolute discretion, without any liability whatsoever.

ANYA

ARABIAN RANCHES III

CONTEMPORARY TOWNHOUSE 4 BEDROOM 1

UNIT	TOTAL AREA	
4PLEX - TH01	2441.14 SQFT	226.79 SQM
6PLEX - TH01	2459.12 SQFT	228.46 SQM
8PLEX - TH01		

KEY PLAN

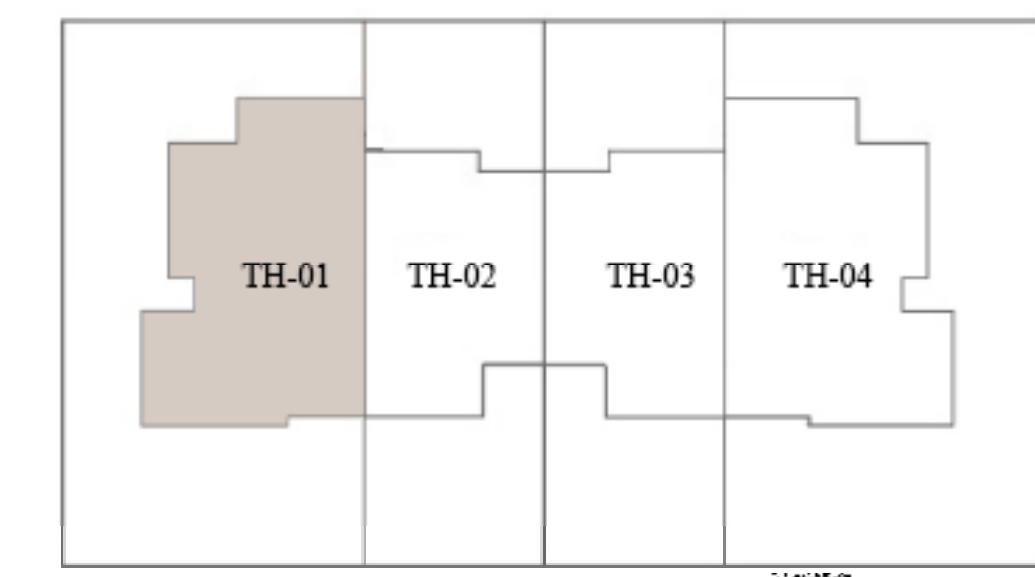

4PLEX - TH01

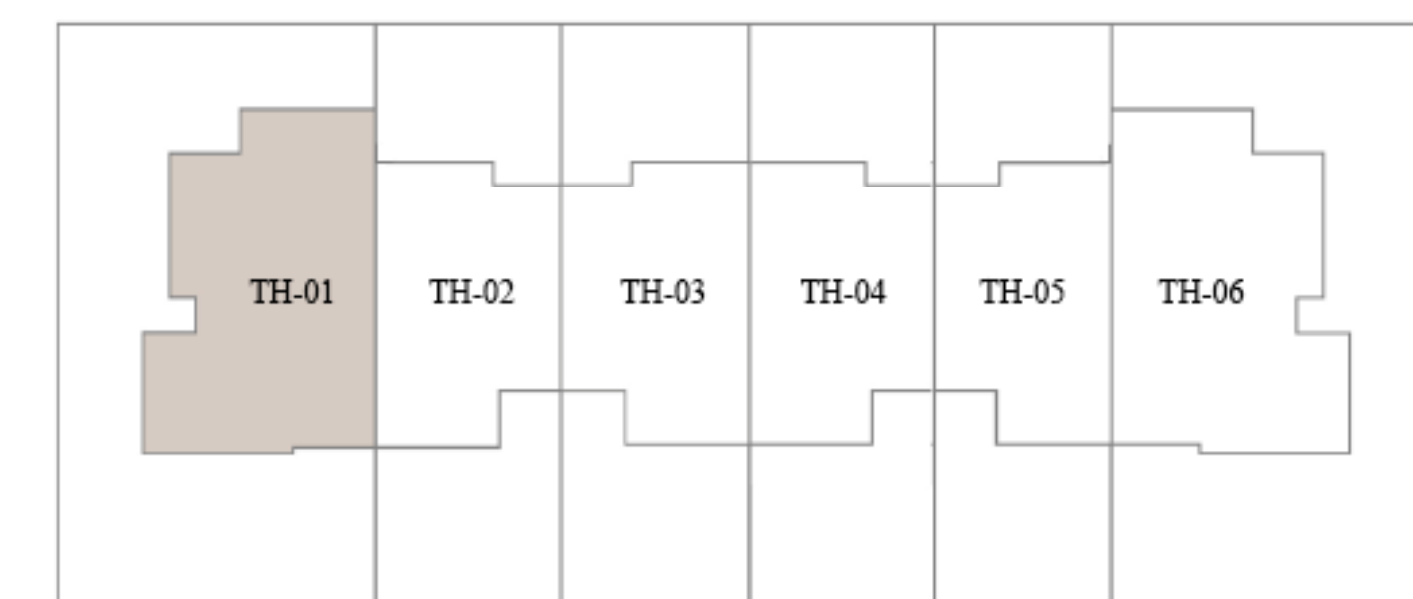

6PLEX - TH01

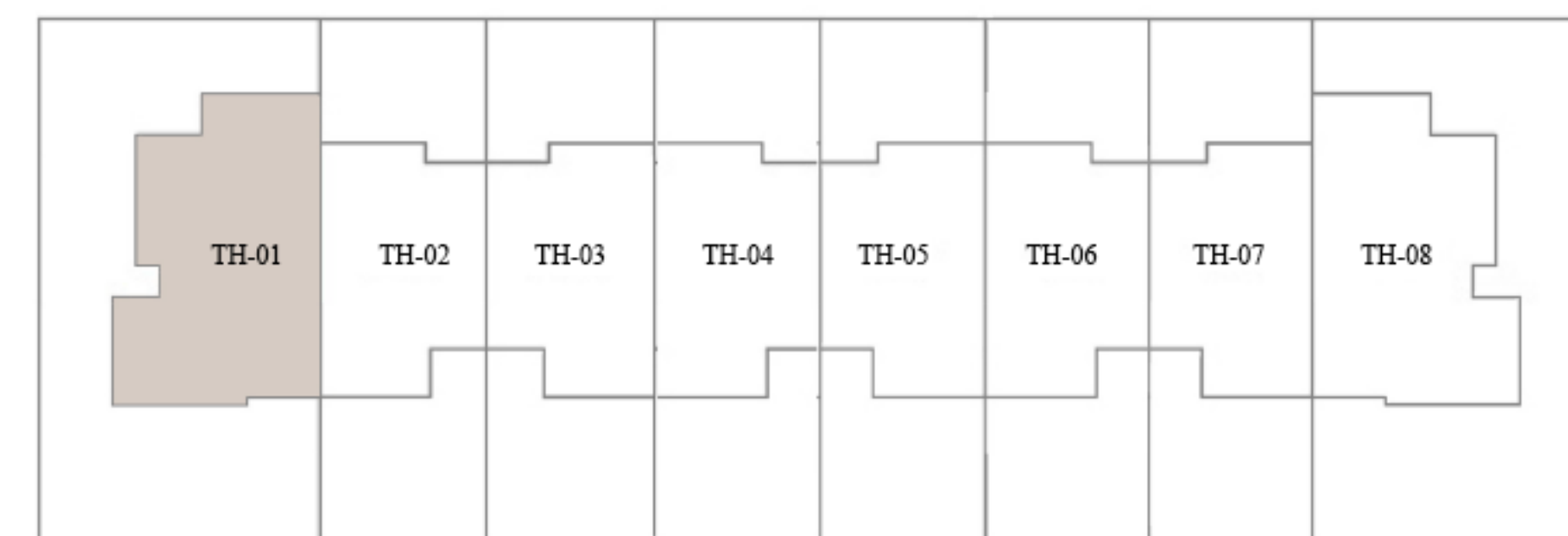

8PLEX - TH01



GROUND FLOOR



FIRST FLOOR

FLOOR PLAN 1. All dimensions are in imperial and metric, and measured from finish to finish excluding construction tolerances. 2. All materials, dimensions, and drawings are approximate only. 3. Information is subject to change without notice, at developer's absolute discretion. 4. Actual area may vary from the stated area. 5. Drawings not to scale. 6. All images used are for illustrative purposes only and do not represent the actual size, features, specifications, fittings, and furnishings. 7. The developer reserves the right to make revisions / alterations, at it's absolute discretion, without any liability whatsoever.

ANYA

ARABIAN RANCHES III

CONTEMPORARY TOWNHOUSE 4 BEDROOM 1 M MIRRORED

UNIT	TOTAL AREA	
4 PLEX - TH04	2441.14 SQFT	226.79 SQM
6 PLEX - TH06	2459.12 SQFT	228.46 SQM
8 PLEX - TH08		

KEY PLAN

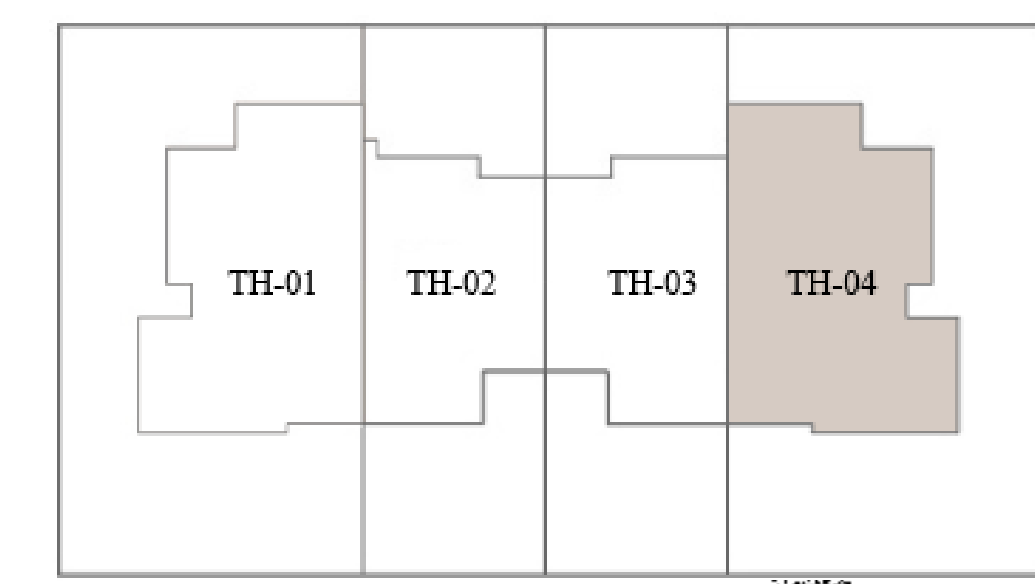

4 PLEX - TH04

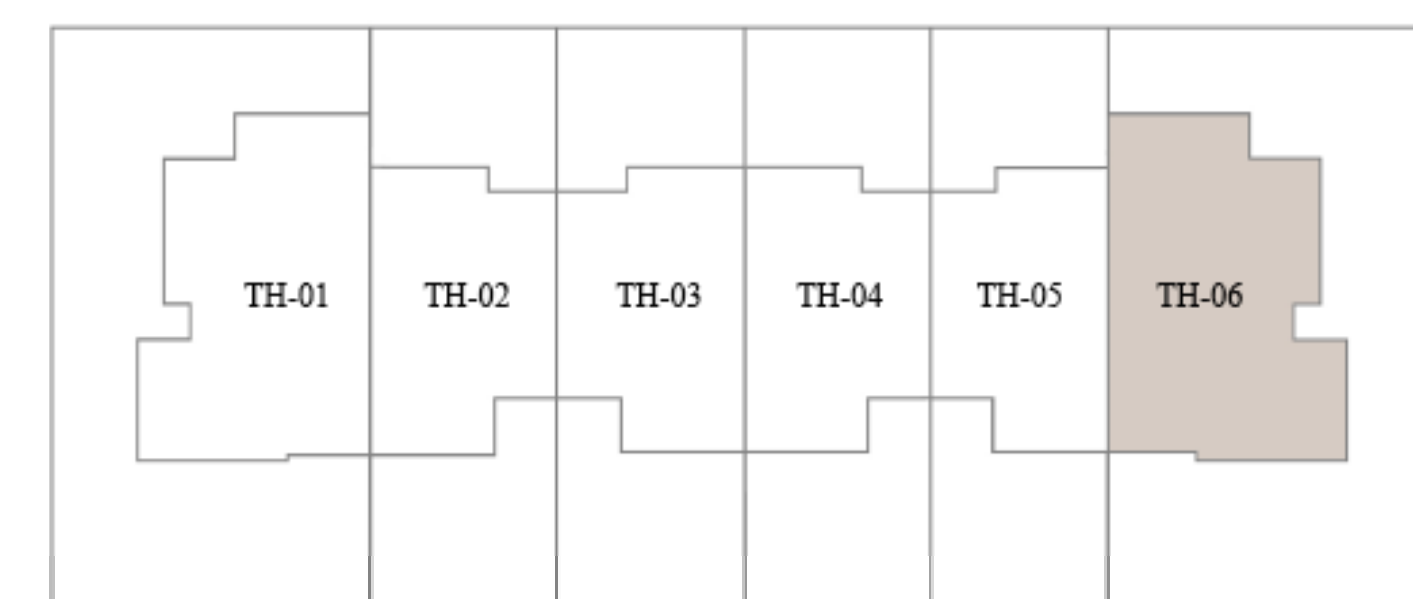

6 PLEX - TH06

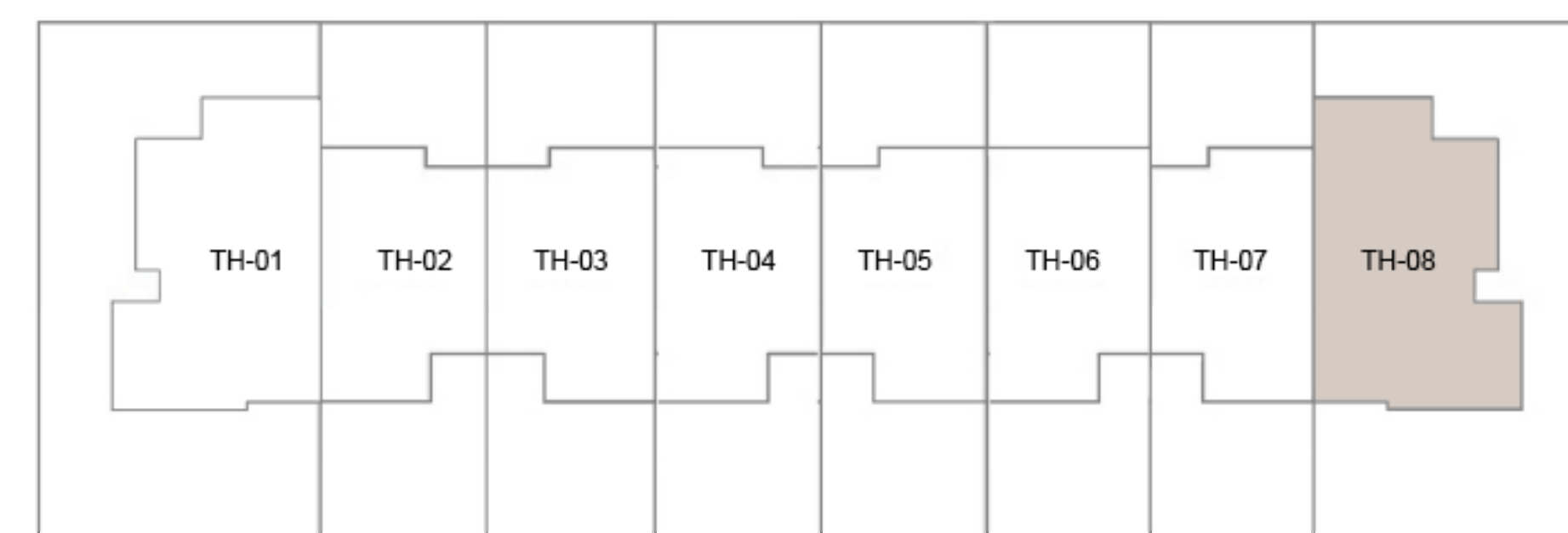

8 PLEX - TH08



GROUND FLOOR



FIRST FLOOR

FLOOR PLAN 1. All dimensions are in imperial and metric, and measured from finish to finish excluding construction tolerances. 2. All materials, dimensions, and drawings are approximate only. 3. Information is subject to change without notice, at developer's absolute discretion. 4. Actual area may vary from the stated area. 5. Drawings not to scale. 6. All images used are for illustrative purposes only and do not represent the actual size, features, specifications, fittings, and furnishings. 7. The developer reserves the right to make revisions / alterations, at it's absolute discretion, without any liability whatsoever.

ANYA

ARABIAN RANCHES III

CONTEMPORARY TOWNHOUSE 3 BEDROOM 1 M MIRRORED

UNIT	TOTAL AREA	
6PLEX - TH05	1929.21 SQFT	179.23 SQM

KEY PLAN

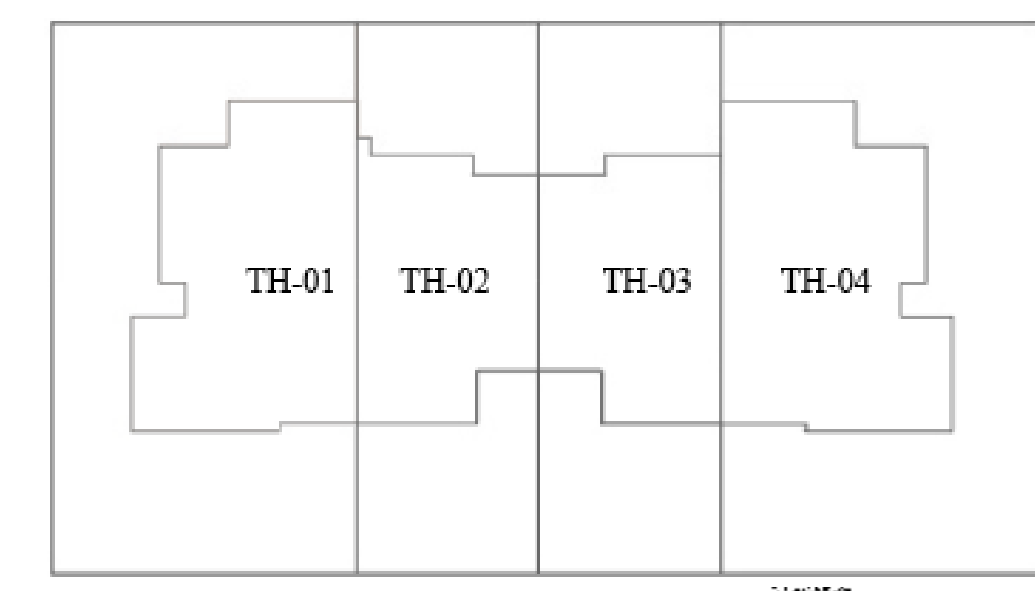

4 PLEX

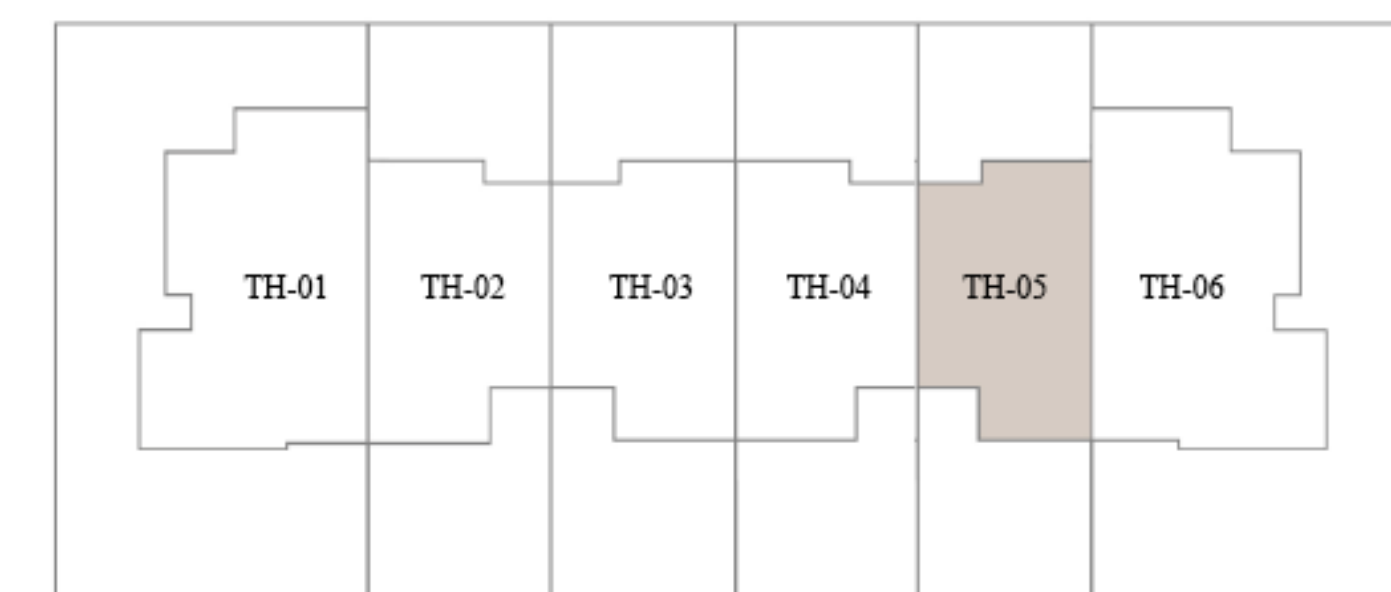

6 PLEX - TH05

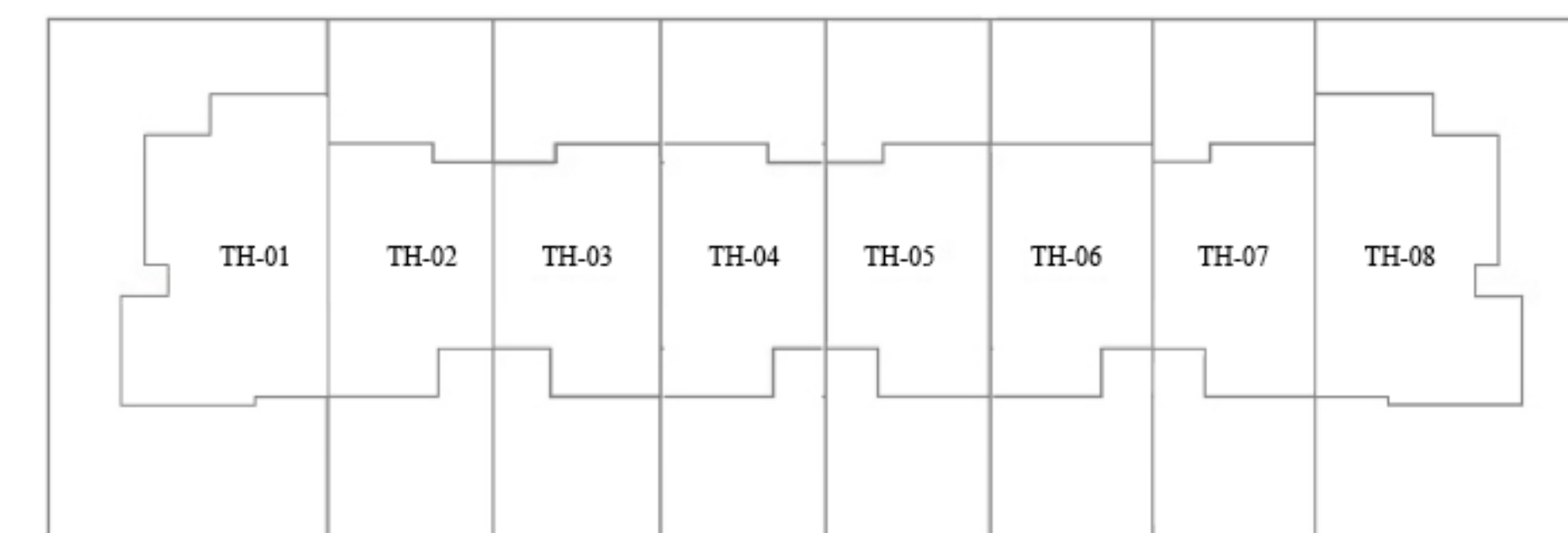

8 PLEX

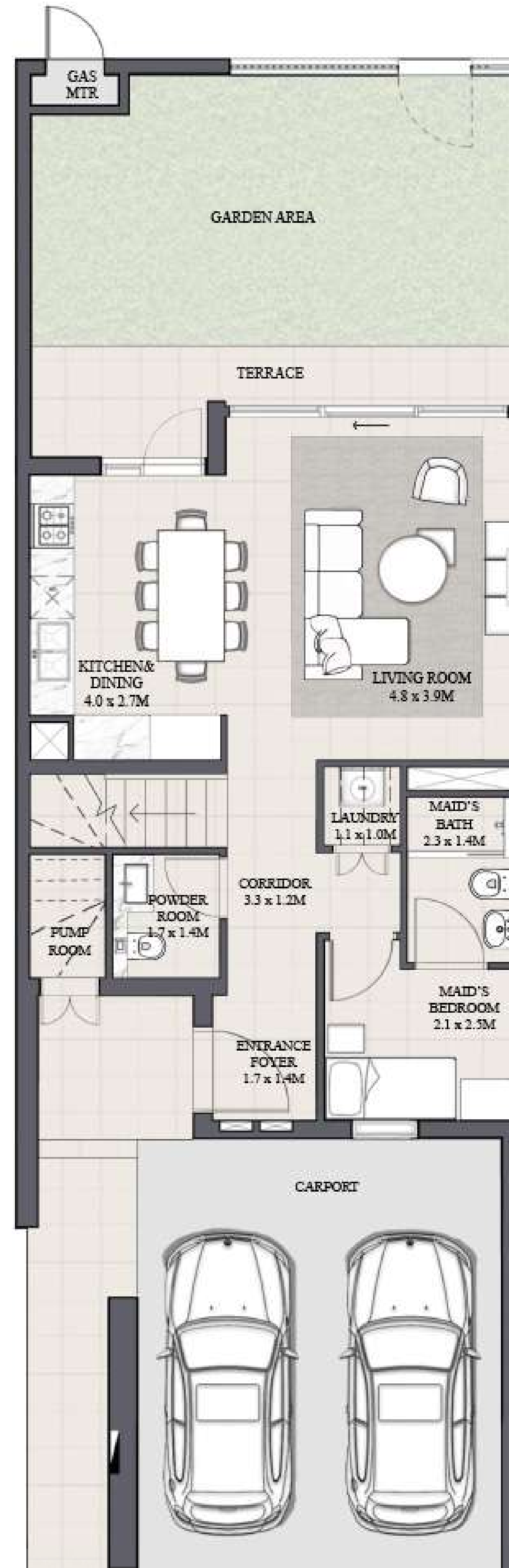

GROUND FLOOR



FIRST FLOOR

FLOOR PLAN 1. All dimensions are in imperial and metric, and measured from finish to finish excluding construction tolerances. 2. All materials, dimensions, and drawings are approximate only. 3. Information is subject to change without notice, at developer's absolute discretion. 4. Actual area may vary from the stated area. 5. Drawings not to scale. 6. All images used are for illustrative purposes only and do not represent the actual size, features, specifications, fittings, and furnishings. 7. The developer reserves the right to make revisions / alterations, at it's absolute discretion, without any liability whatsoever.

ANYA

ARABIAN RANCHES III

CONTEMPORARY TOWNHOUSE 3 BEDROOM 2

UNIT	TOTAL AREA	
4 PLEX - TH03	1937.07 SQFT	179.96 SQM

KEY PLAN

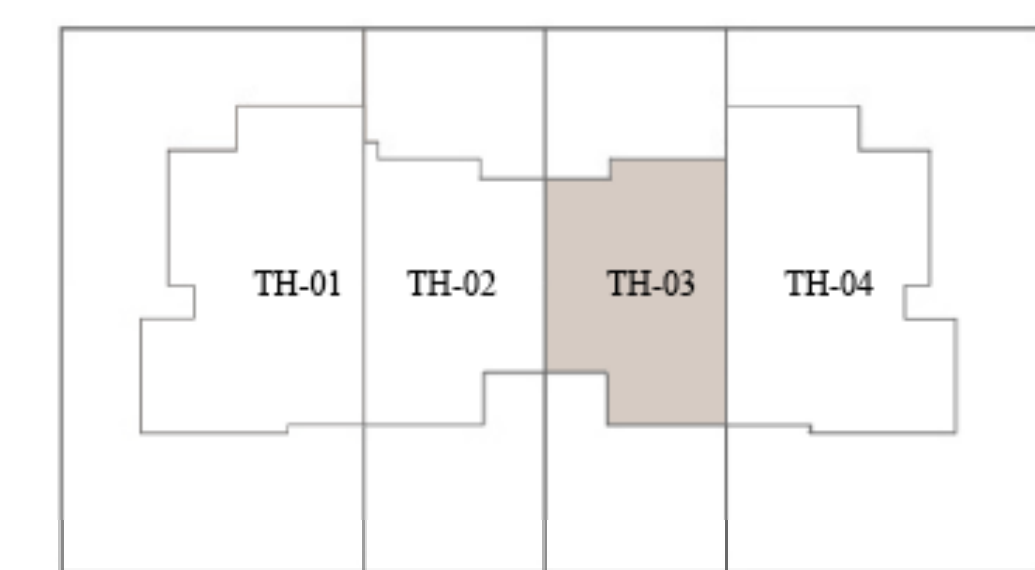

4 PLEX - TH03

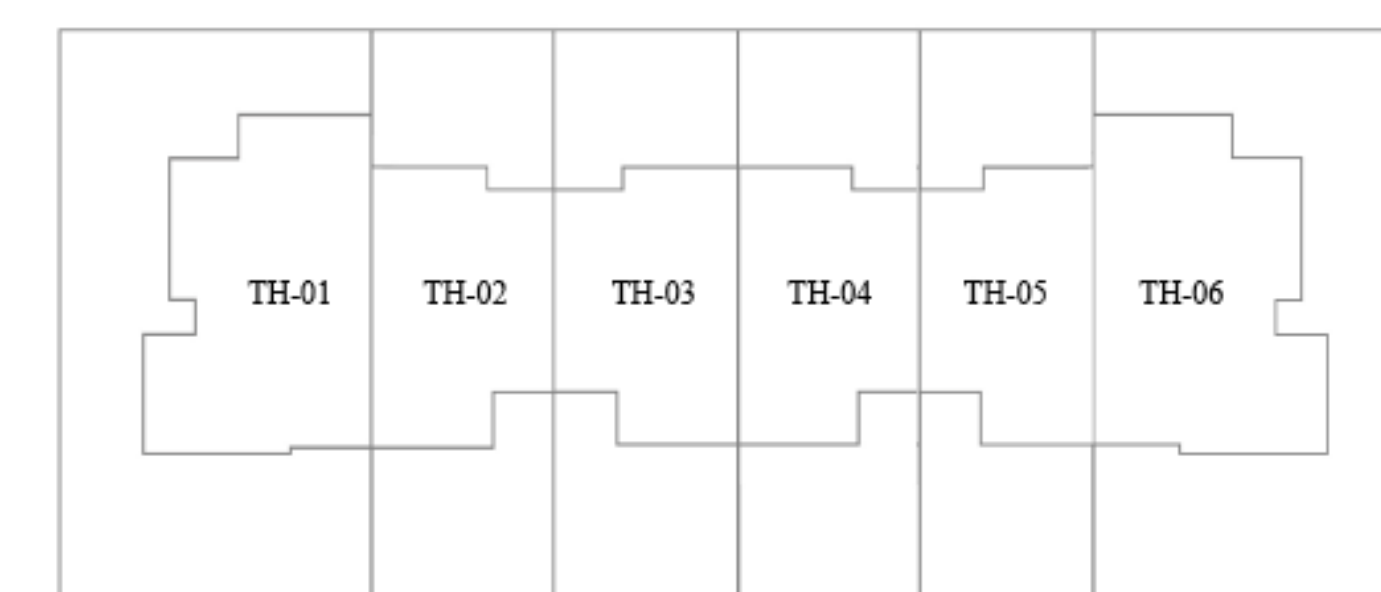

6 PLEX

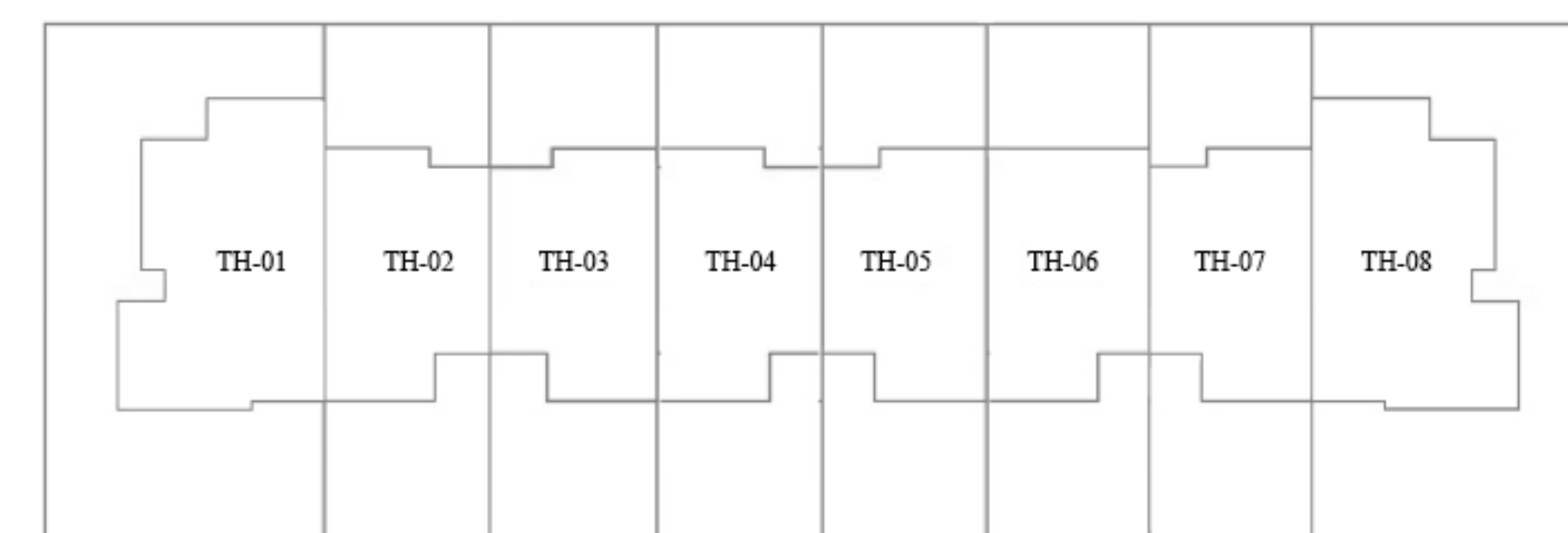

8 PLEX

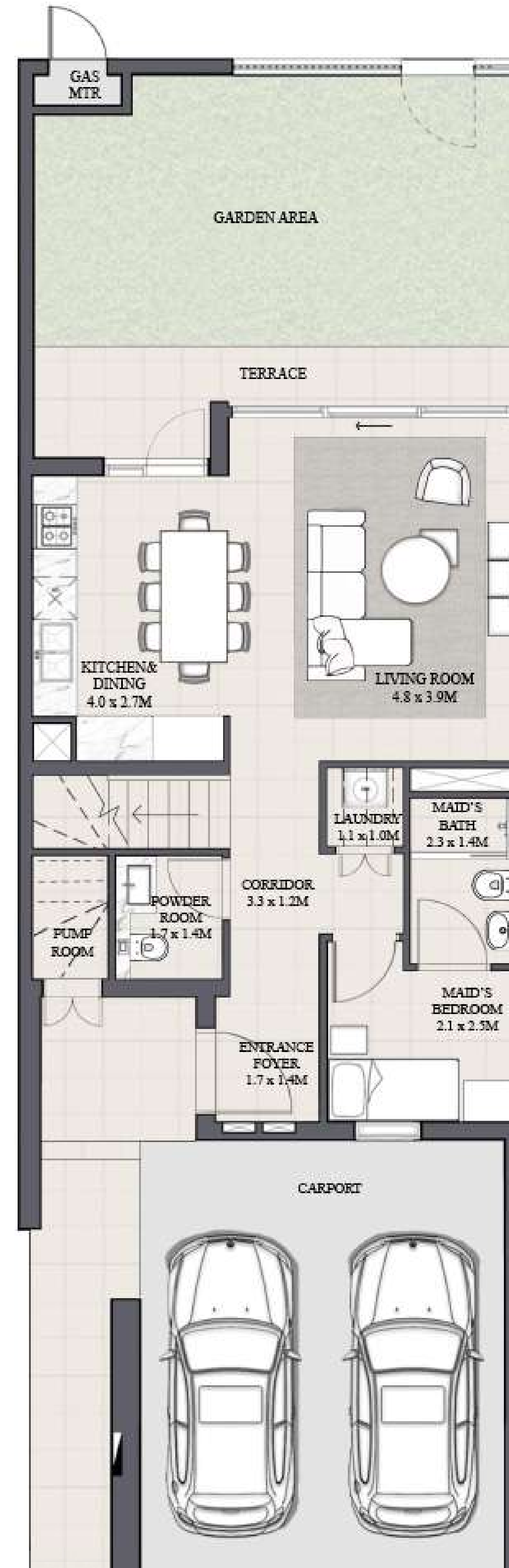

GROUND FLOOR



FIRST FLOOR

FLOOR PLAN 1. All dimensions are in imperial and metric, and measured from finish to finish excluding construction tolerances. 2. All materials, dimensions, and drawings are approximate only. 3. Information is subject to change without notice, at developer's absolute discretion. 4. Actual area may vary from the stated area. 5. Drawings not to scale. 6. All images used are for illustrative purposes only and do not represent the actual size, features, specifications, fittings, and furnishings. 7. The developer reserves the right to make revisions / alterations, at its absolute discretion, without any liability whatsoever.

ANYA

ARABIAN RANCHES III

CONTEMPORARY TOWNHOUSE 3 BEDROOM 3

UNIT	TOTAL AREA	
6 PLEX - TH03	1931.04 SQFT	179.40 SQM

KEY PLAN

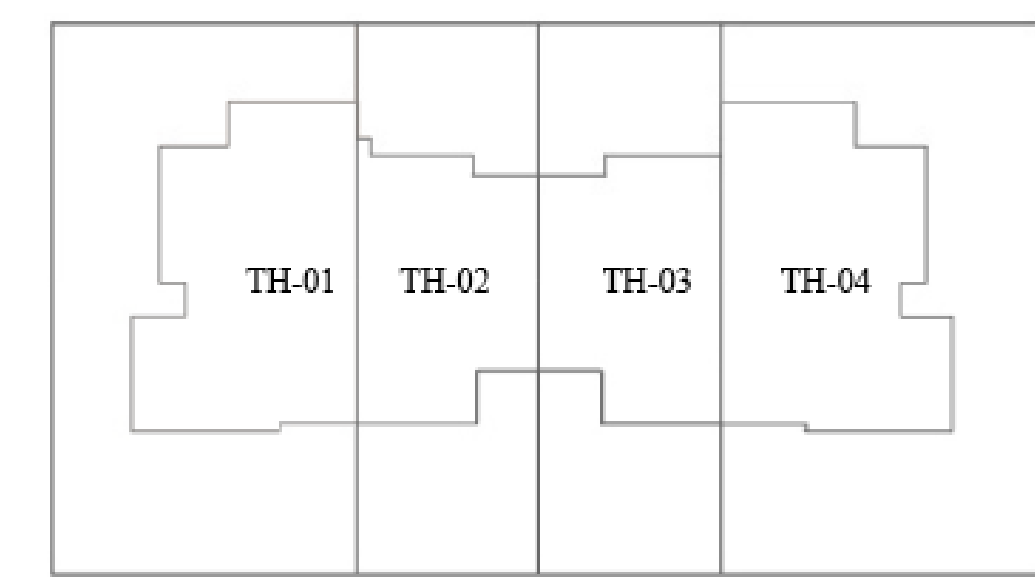

4 PLEX

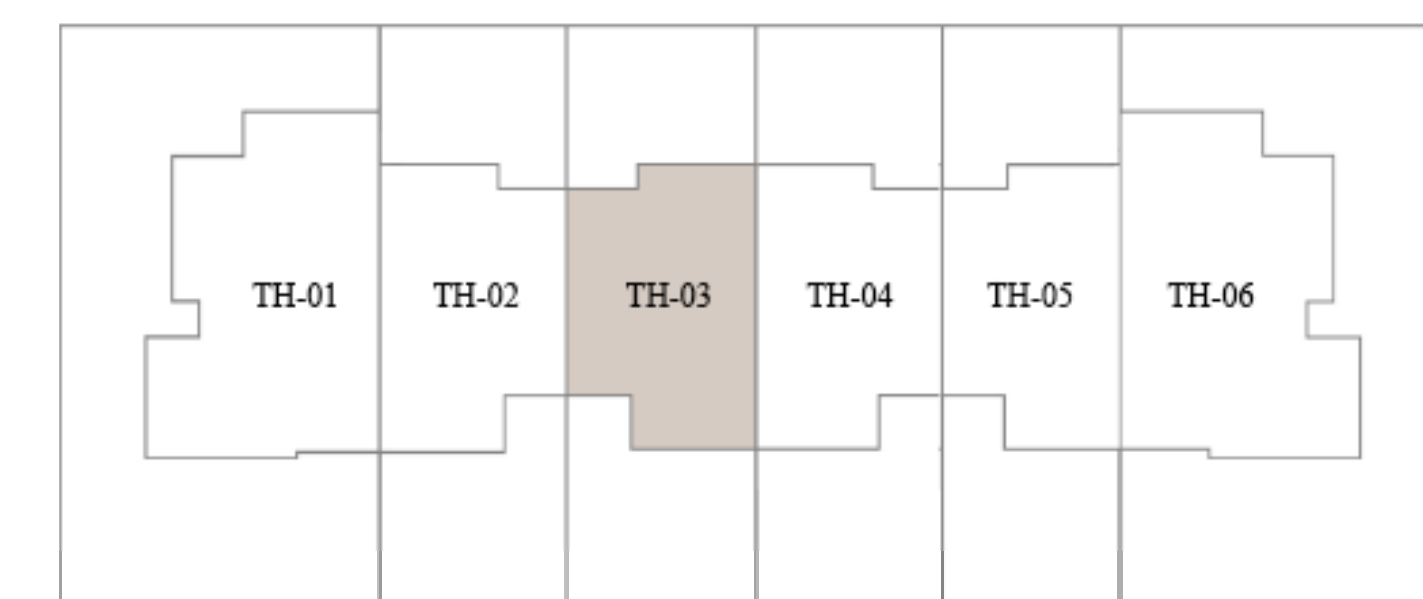

6 PLEX - TH03

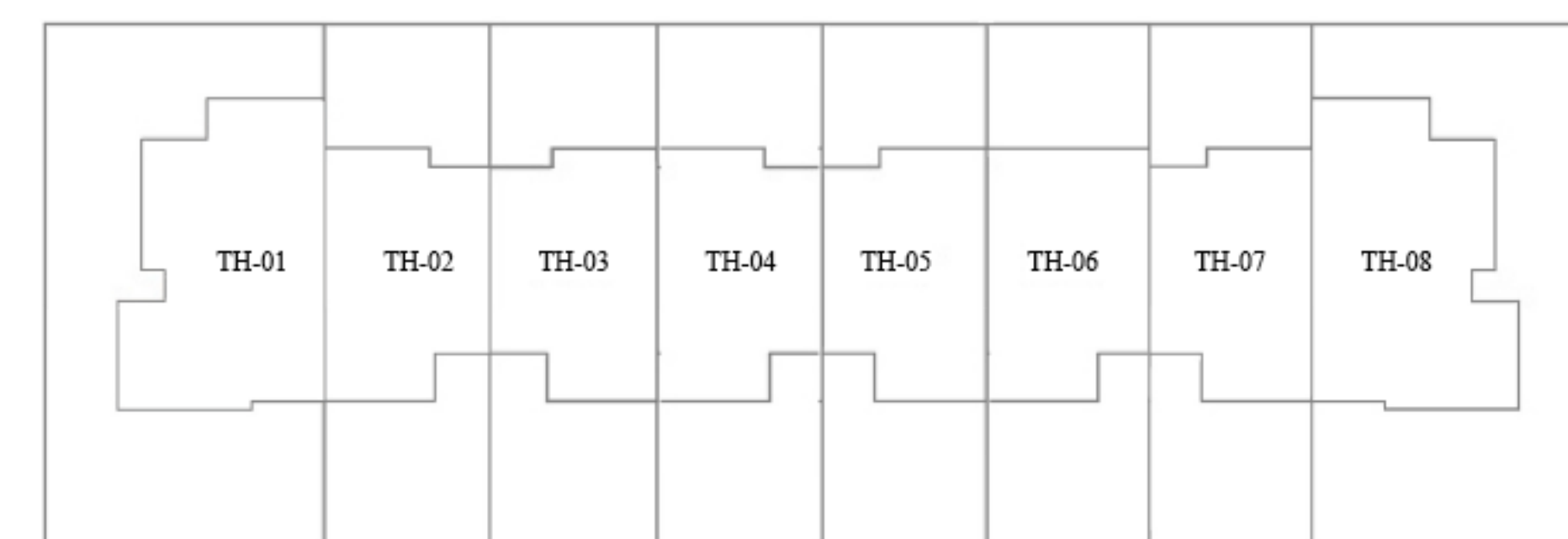

8 PLEX

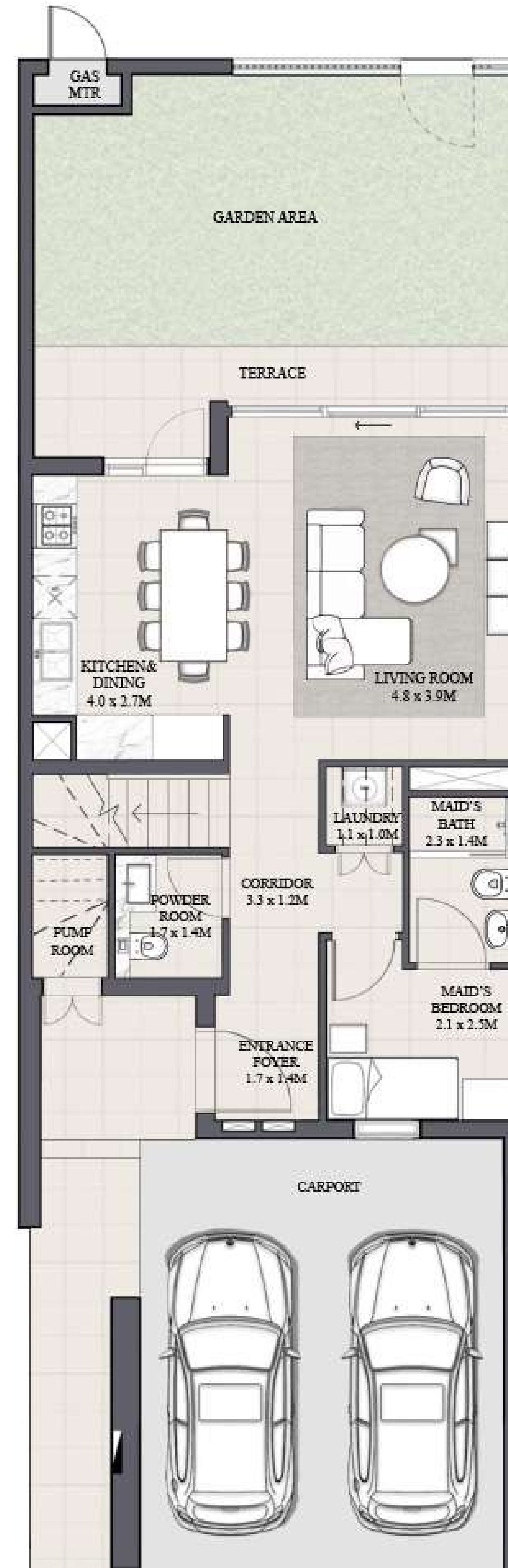

GROUND FLOOR



FIRST FLOOR

FLOOR PLAN 1. All dimensions are in imperial and metric, and measured from finish to finish excluding construction tolerances. 2. All materials, dimensions, and drawings are approximate only. 3. Information is subject to change without notice, at developer's absolute discretion. 4. Actual area may vary from the stated area. 5. Drawings not to scale. 6. All images used are for illustrative purposes only and do not represent the actual size, features, specifications, fittings, and furnishings. 7. The developer reserves the right to make revisions / alterations, at its absolute discretion, without any liability whatsoever.

ANYA

ARABIAN RANCHES III

CONTEMPORARY TOWNHOUSE 3 BEDROOM 3 M MIRRORED

UNIT	TOTAL AREA	
6 PLEX - TH04	1930.61 SQFT	179.36 SQM

KEY PLAN

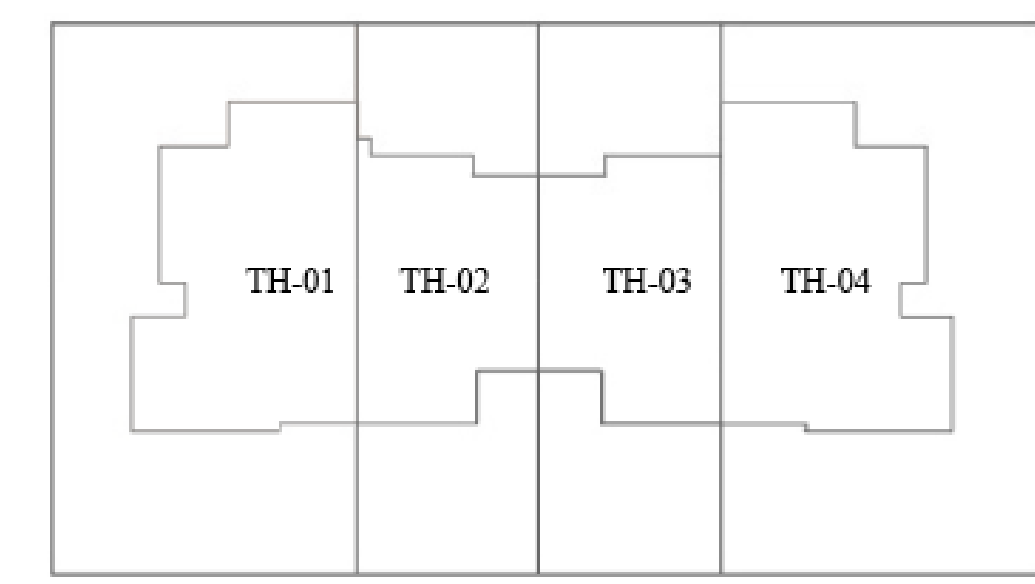

4 PLEX

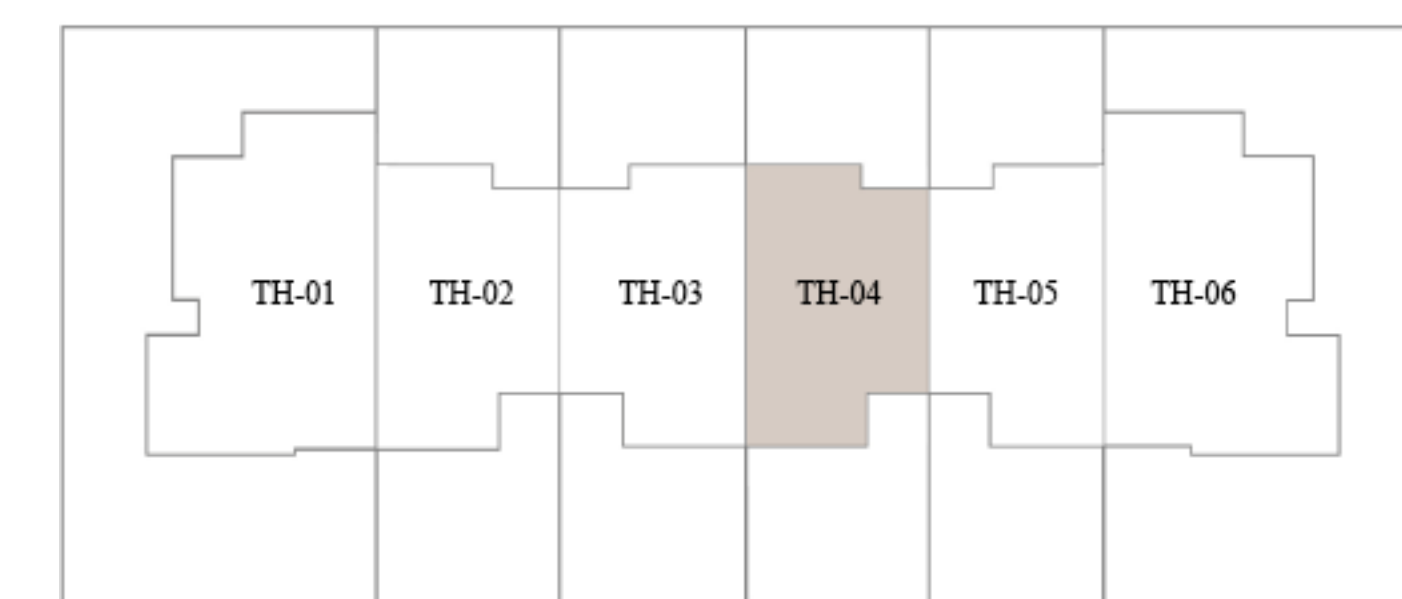

6 PLEX - TH04

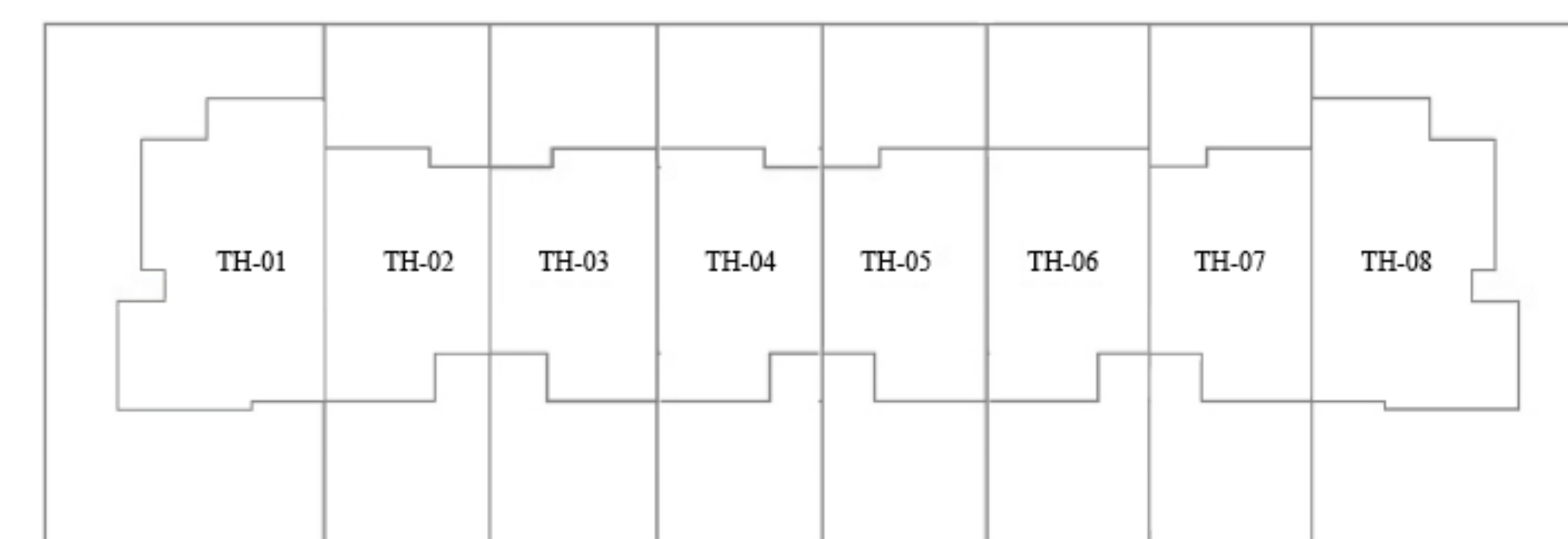

8 PLEX

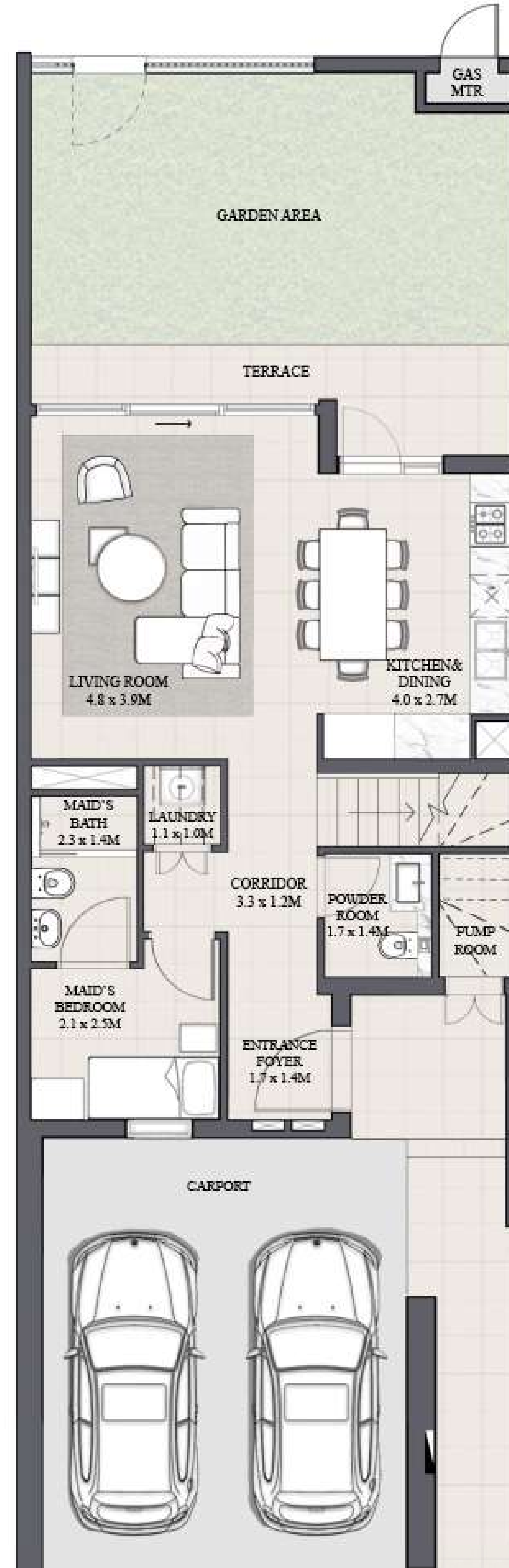

GROUND FLOOR



FIRST FLOOR

FLOOR PLAN 1. All dimensions are in imperial and metric, and measured from finish to finish excluding construction tolerances. 2. All materials, dimensions, and drawings are approximate only. 3. Information is subject to change without notice, at developer's absolute discretion. 4. Actual area may vary from the stated area. 5. Drawings not to scale. 6. All images used are for illustrative purposes only and do not represent the actual size, features, specifications, fittings, and furnishings. 7. The developer reserves the right to make revisions / alterations, at its absolute discretion, without any liability whatsoever.

ANYA

ARABIAN RANCHES III

CONTEMPORARY TOWNHOUSE 3 BEDROOM 4

UNIT	TOTAL AREA	
8 PLEX - TH02	1927.49 SQFT	179.07 SQM

KEY PLAN

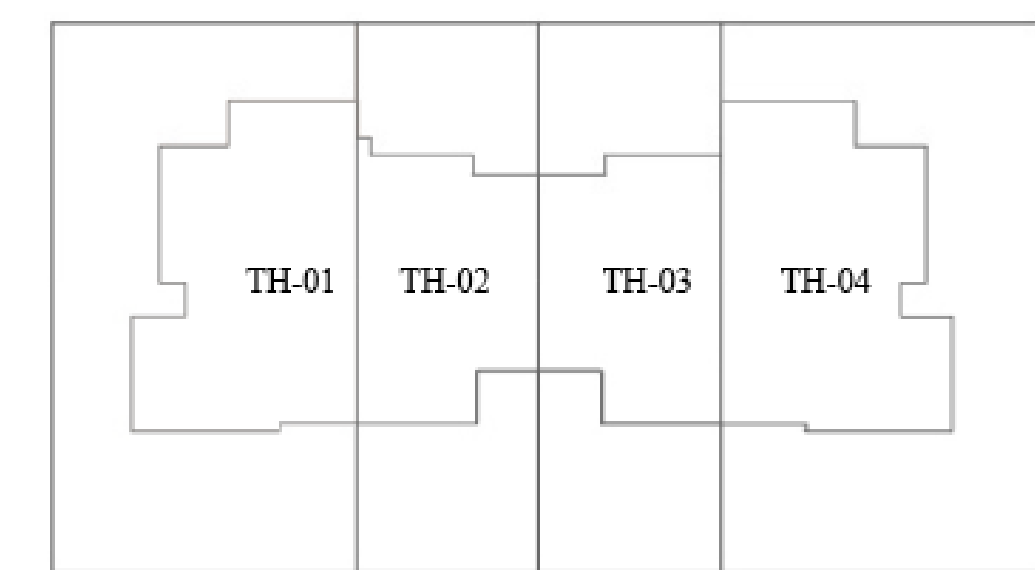

4 PLEX

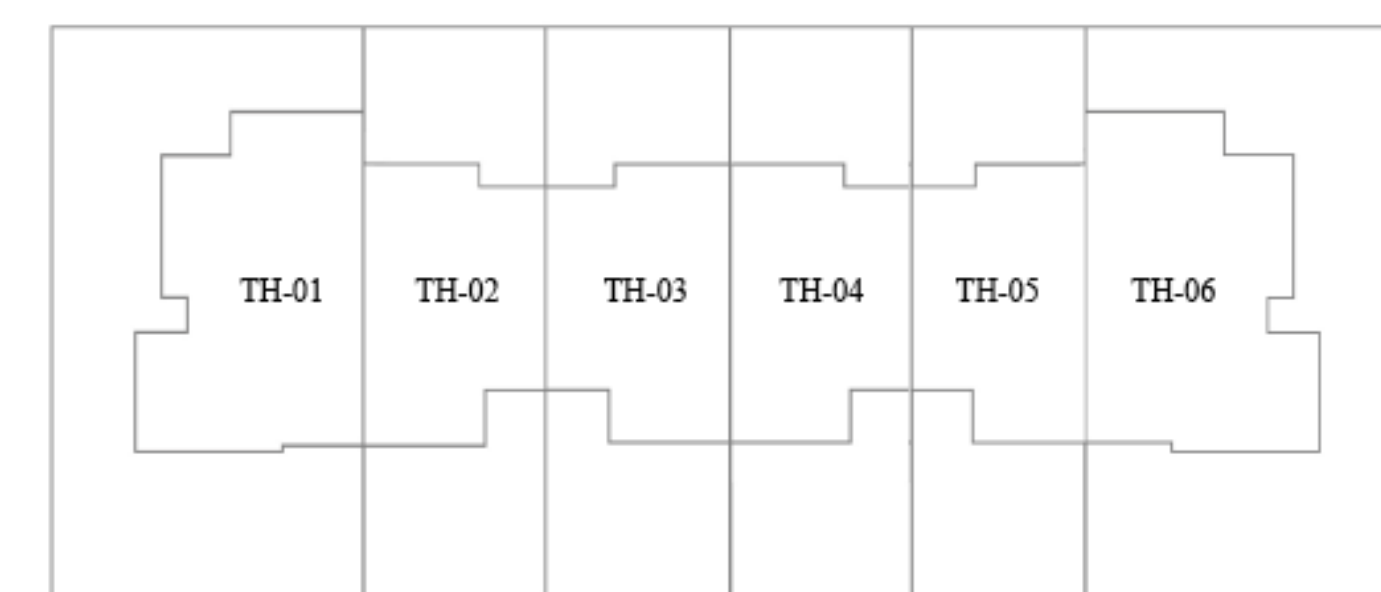

6 PLEX

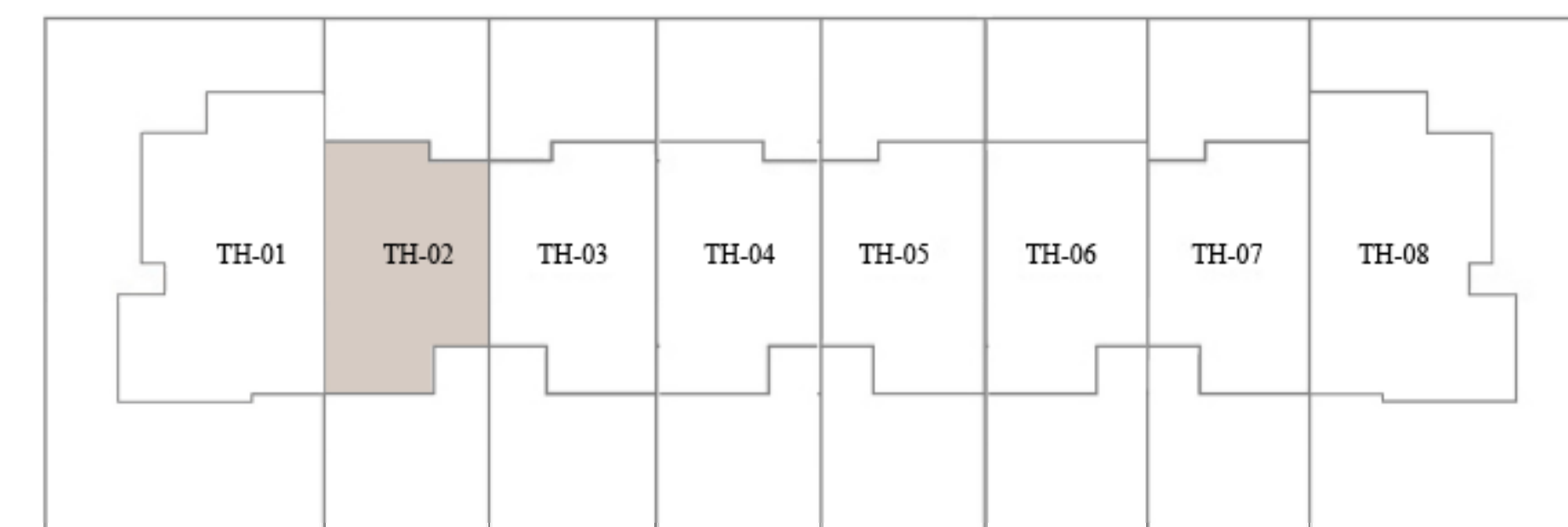

8 PLEX - TH02

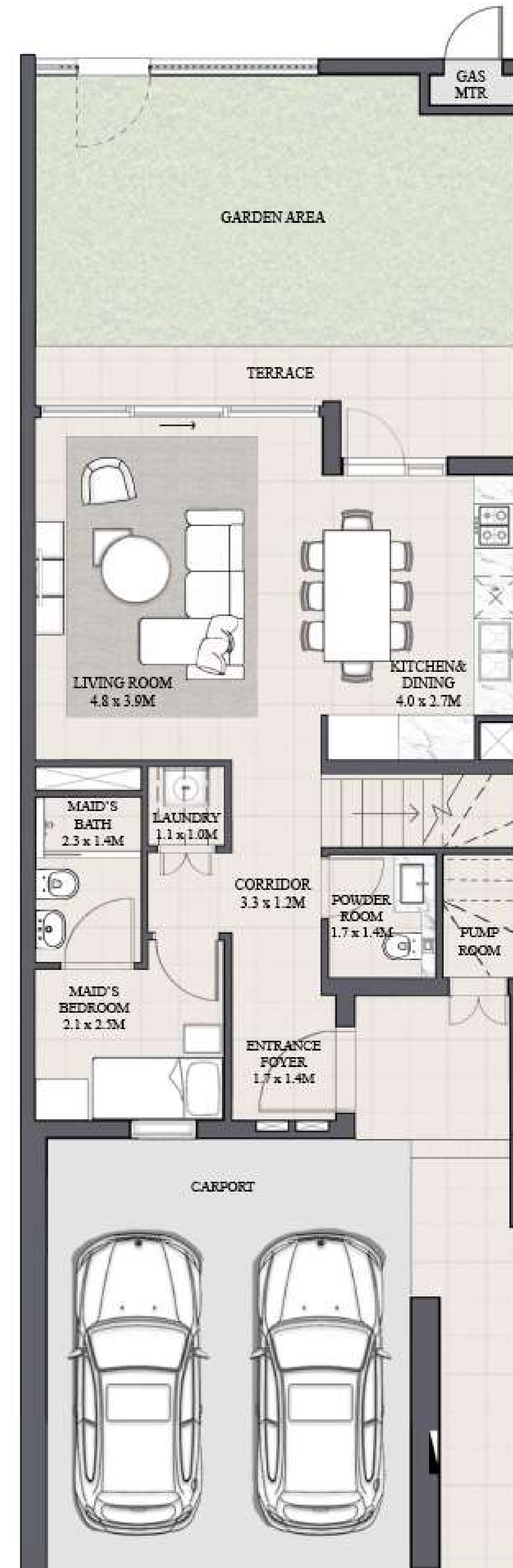

GROUND FLOOR



FIRST FLOOR

FLOOR PLAN 1. All dimensions are in imperial and metric, and measured from finish to finish excluding construction tolerances. 2. All materials, dimensions, and drawings are approximate only. 3. Information is subject to change without notice, at developer's absolute discretion. 4. Actual area may vary from the stated area. 5. Drawings not to scale. 6. All images used are for illustrative purposes only and do not represent the actual size, features, specifications, fittings, and furnishings. 7. The developer reserves the right to make revisions / alterations, at it's absolute discretion, without any liability whatsoever.

ANYA

ARABIAN RANCHES III

CONTEMPORARY TOWNHOUSE 3 BEDROOM 4 M MIRRORED

UNIT	TOTAL AREA	
8 PLEX - TH07	1927.49 SQFT	179.07 SQM

KEY PLAN

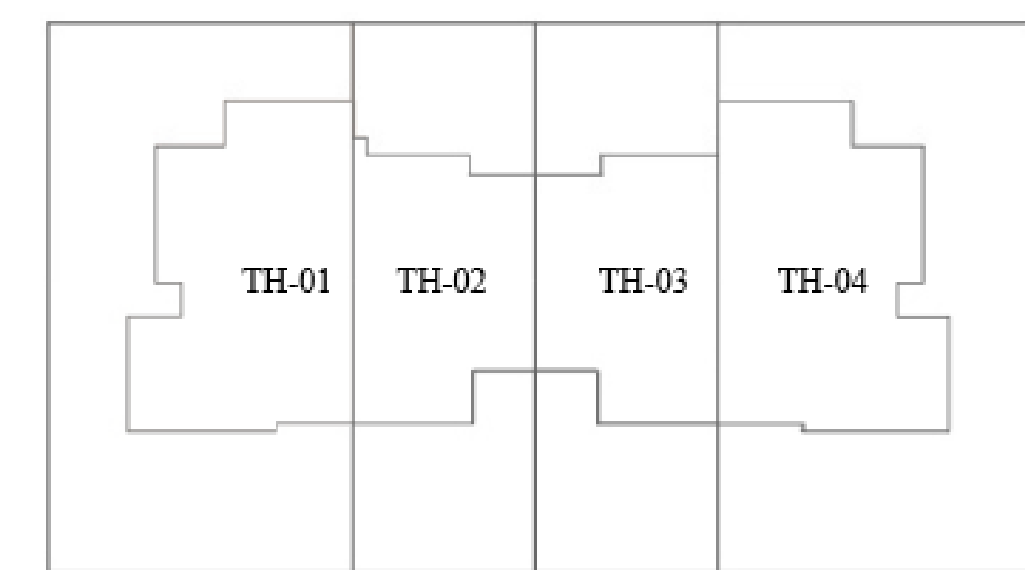

4 PLEX - TH03

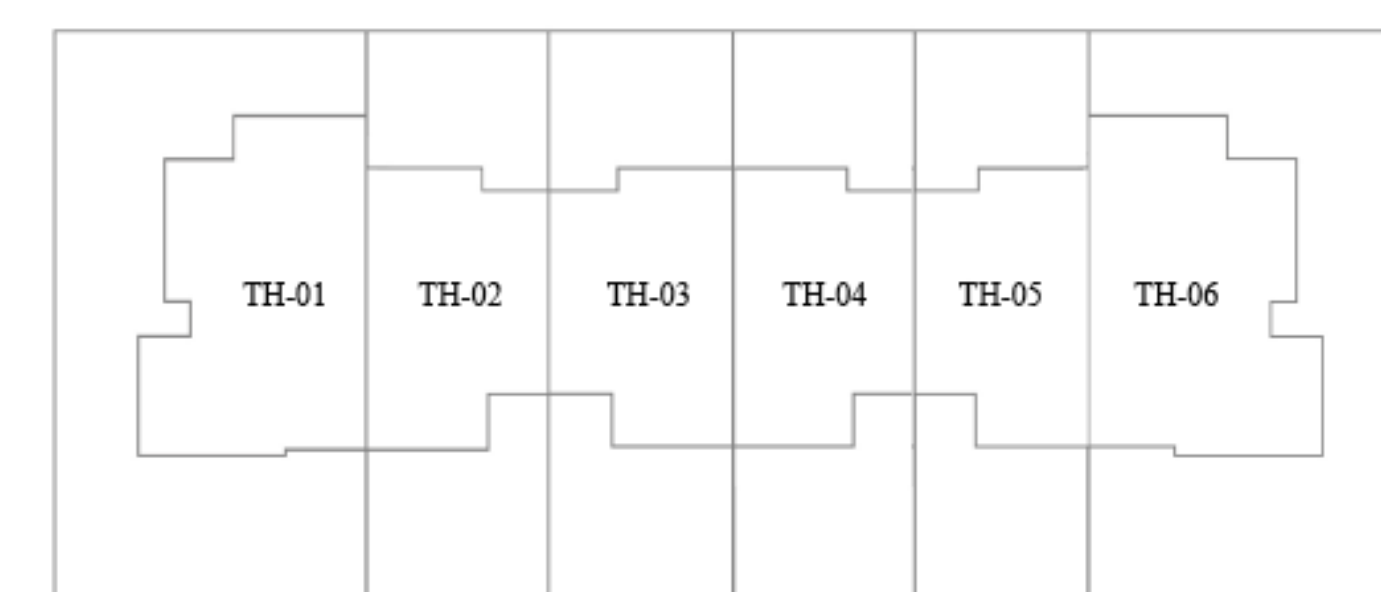

6 PLEX

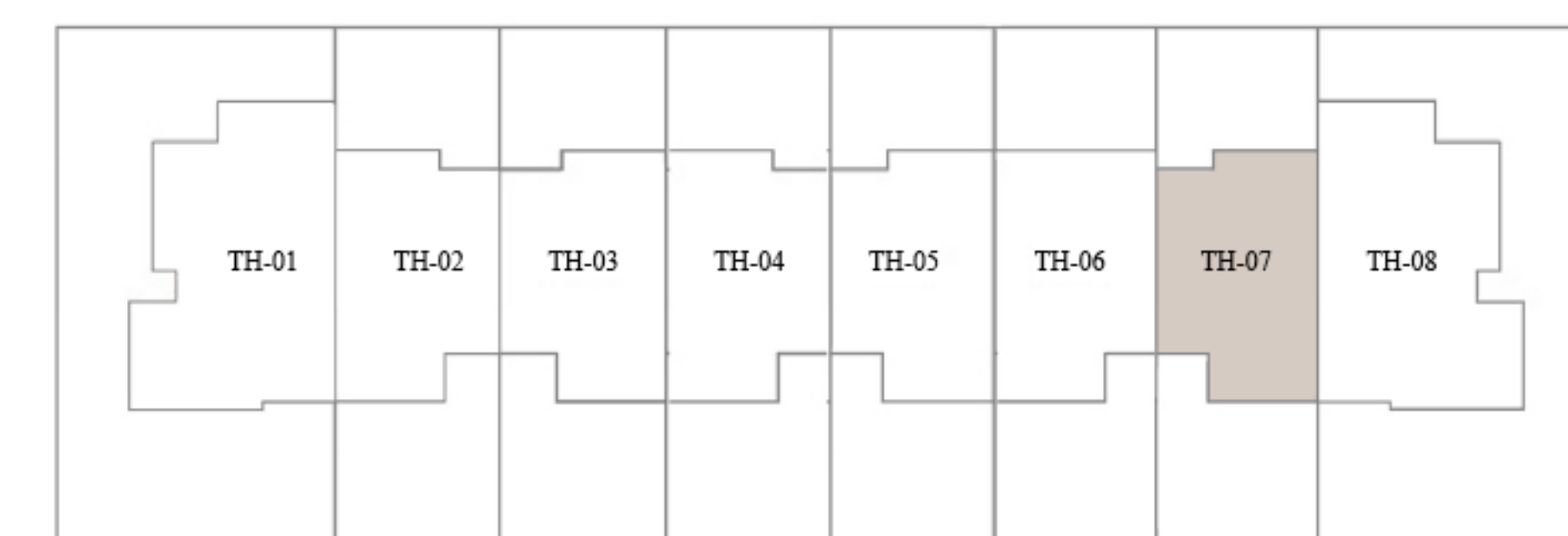

8 PLEX - TH07



GROUND FLOOR



FIRST FLOOR

FLOOR PLAN 1. All dimensions are in imperial and metric, and measured from finish to finish excluding construction tolerances. 2. All materials, dimensions, and drawings are approximate only. 3. Information is subject to change without notice, at developer's absolute discretion. 4. Actual area may vary from the stated area. 5. Drawings not to scale. 6. All images used are for illustrative purposes only and do not represent the actual size, features, specifications, fittings, and furnishings. 7. The developer reserves the right to make revisions / alterations, at its absolute discretion, without any liability whatsoever.

ANYA

ARABIAN RANCHES III

CONTEMPORARY TOWNHOUSE 3 BEDROOM 5

UNIT	TOTAL AREA	
8 PLEX - TH03	1935.24 SQFT	179.79 SQM

KEY PLAN

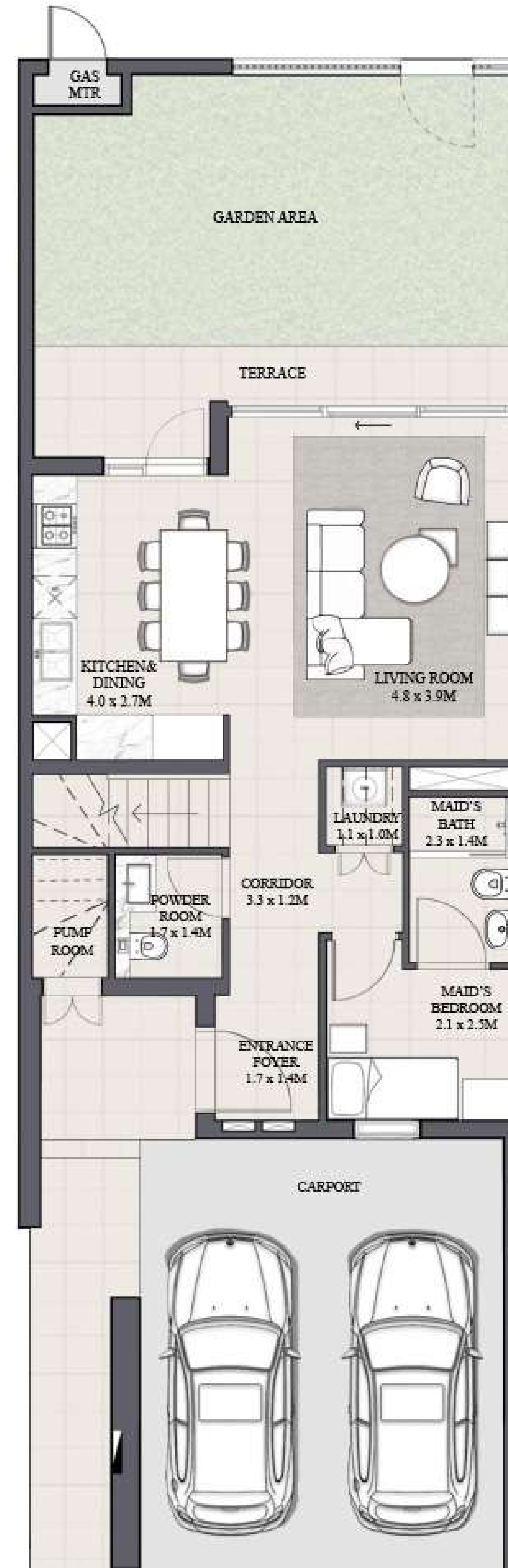

GROUND FLOOR



FIRST FLOOR

FLOOR PLAN 1. All dimensions are in imperial and metric, and measured from finish to finish excluding construction tolerances. 2. All materials, dimensions, and drawings are approximate only. 3. Information is subject to change without notice, at developer's absolute discretion. 4. Actual area may vary from the stated area. 5. Drawings not to scale. 6. All images used are for illustrative purposes only and do not represent the actual size, features, specifications, fittings, and furnishings. 7. The developer reserves the right to make revisions / alterations, at its absolute discretion, without any liability whatsoever.

ANYA

ARABIAN RANCHES III

CONTEMPORARY TOWNHOUSE 3 BEDROOM 5 M MIRRORED

UNIT	TOTAL AREA	
8 PLEX - TH06	1935.24 SQFT	179.79 SQM

KEY PLAN

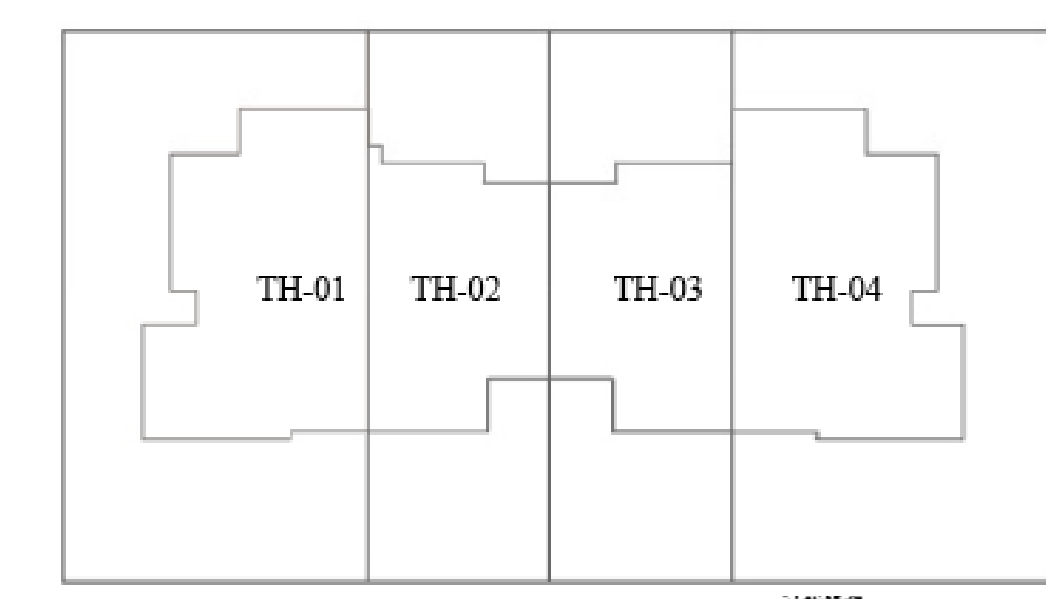

4 PLEX

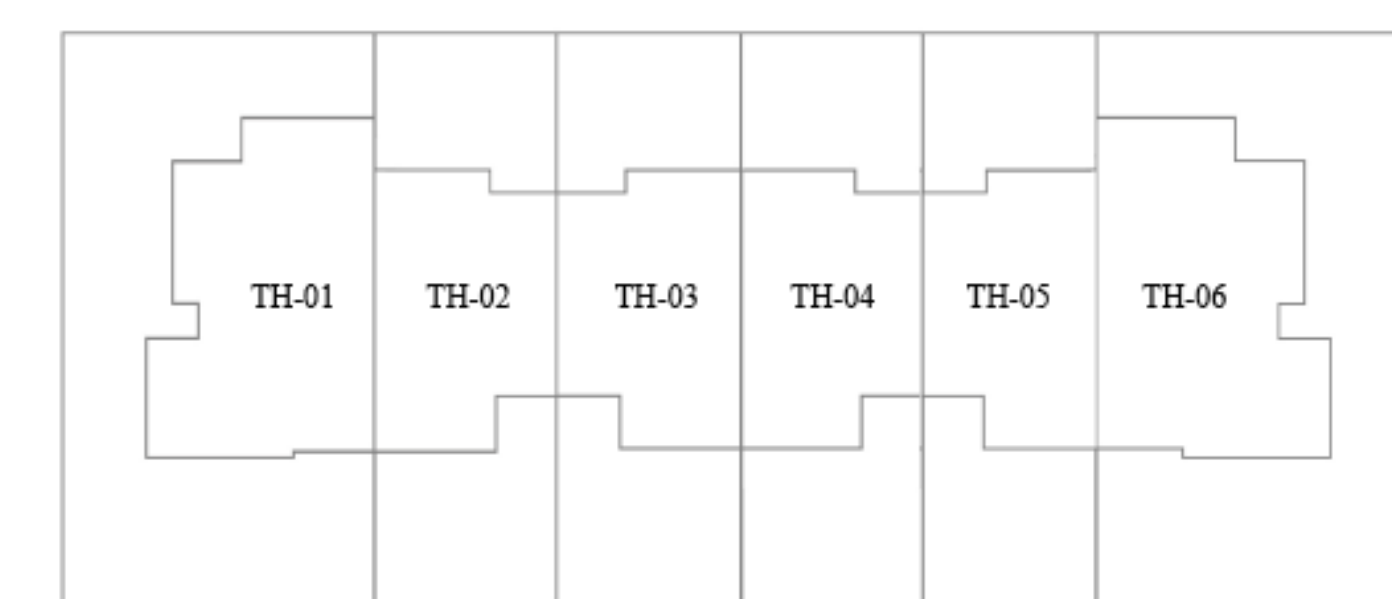

6 PLEX

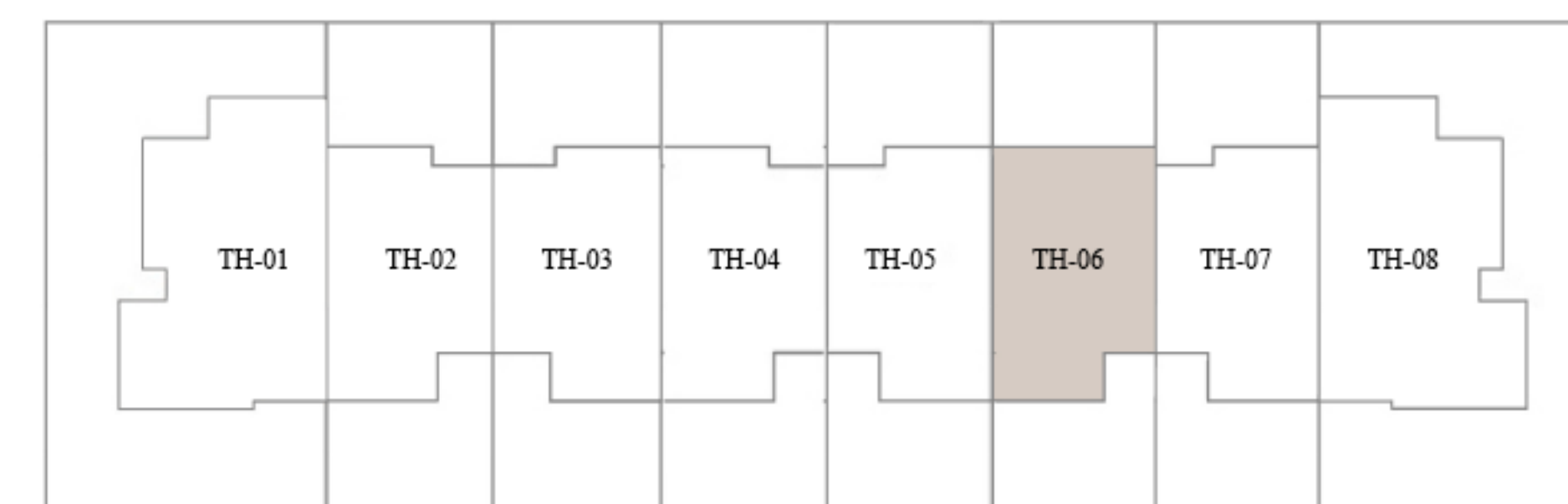

8 PLEX - TH06



GROUND FLOOR



FIRST FLOOR

FLOOR PLAN 1. All dimensions are in imperial and metric, and measured from finish to finish excluding construction tolerances. 2. All materials, dimensions, and drawings are approximate only. 3. Information is subject to change without notice, at developer's absolute discretion. 4. Actual area may vary from the stated area. 5. Drawings not to scale. 6. All images used are for illustrative purposes only and do not represent the actual size, features, specifications, fittings, and furnishings. 7. The developer reserves the right to make revisions / alterations, at it's absolute discretion, without any liability whatsoever.

ANYA

ARABIAN RANCHES III

CONTEMPORARY TOWNHOUSE 3 BEDROOM 6

UNIT	TOTAL AREA	
8 PLEX - TH04	1915.65 SQFT	177.97 SQM

KEY PLAN

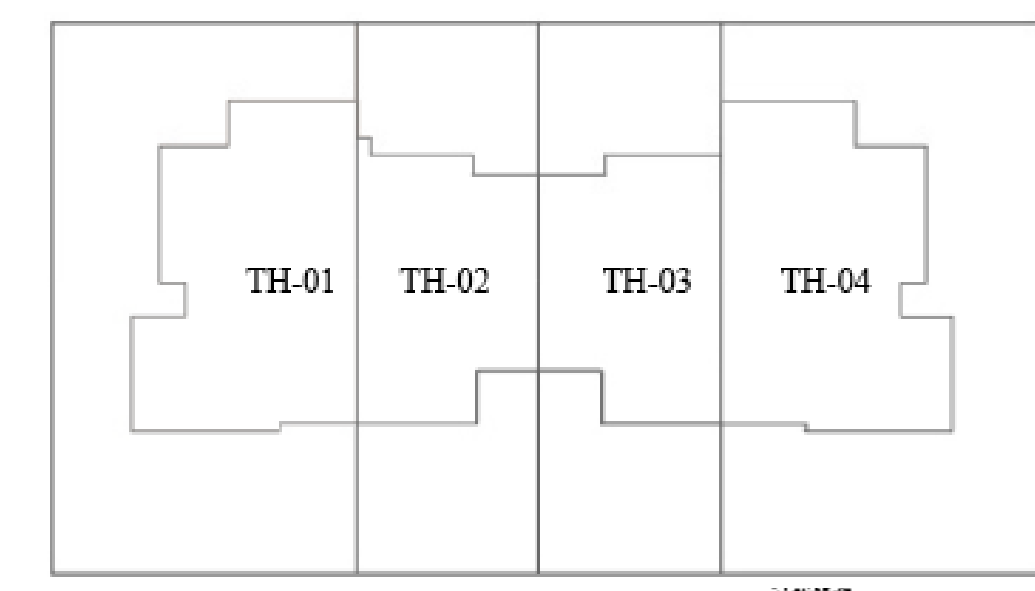

4 PLEX

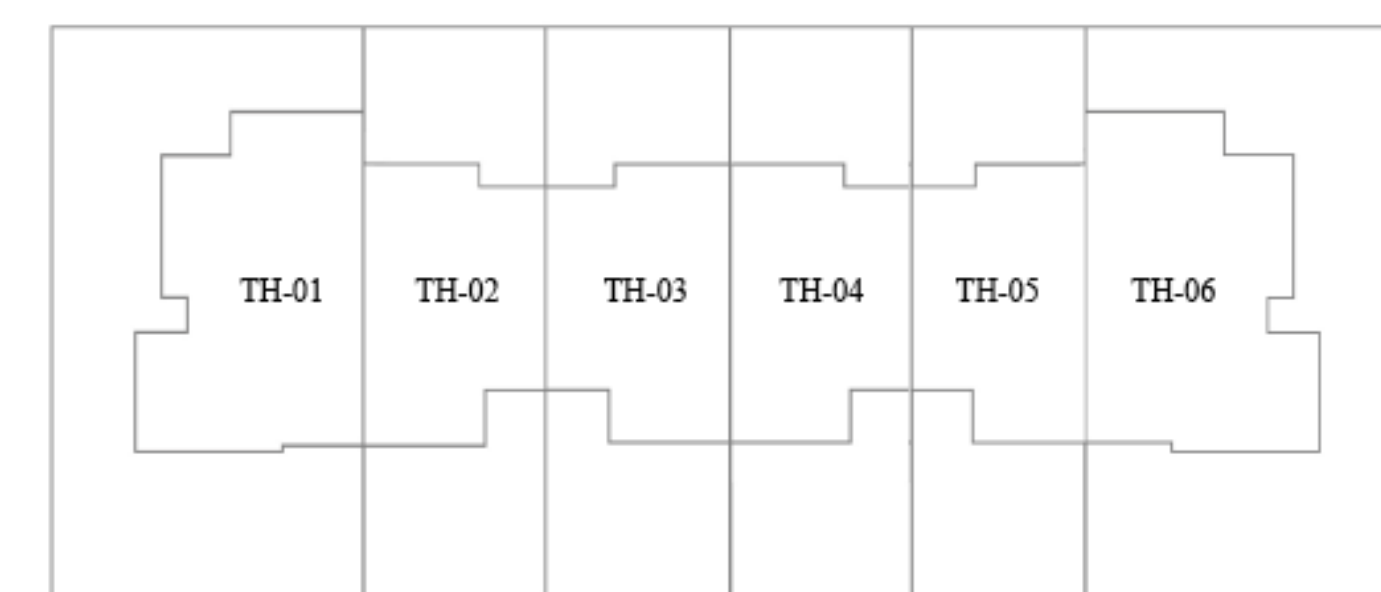

6 PLEX

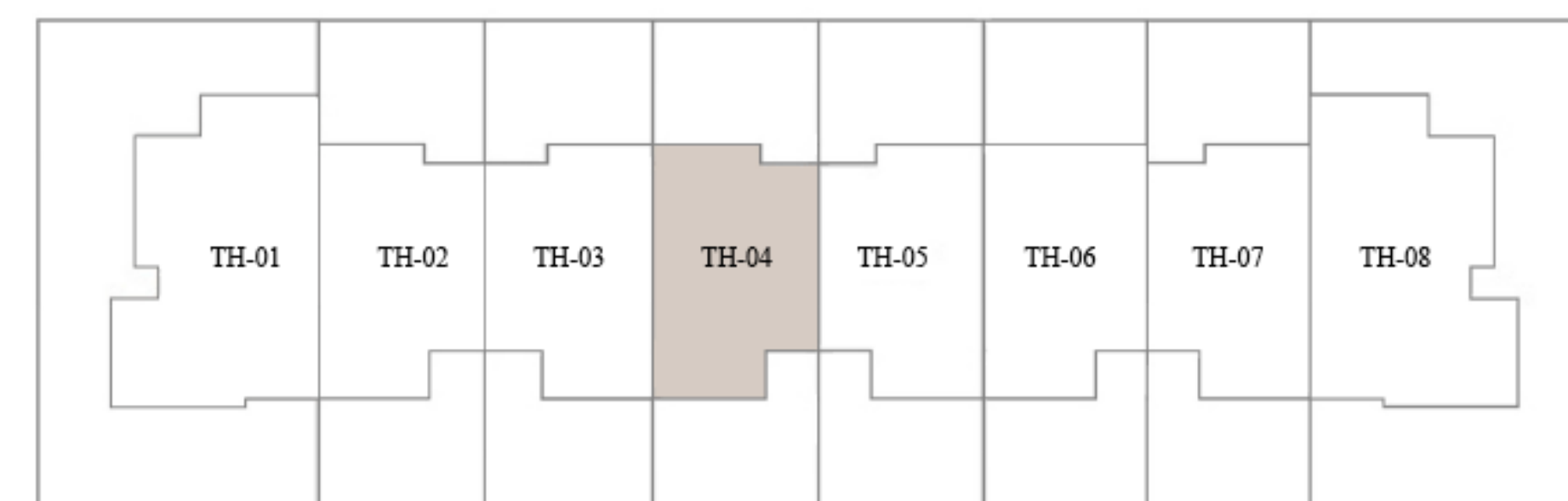

8 PLEX - TH04

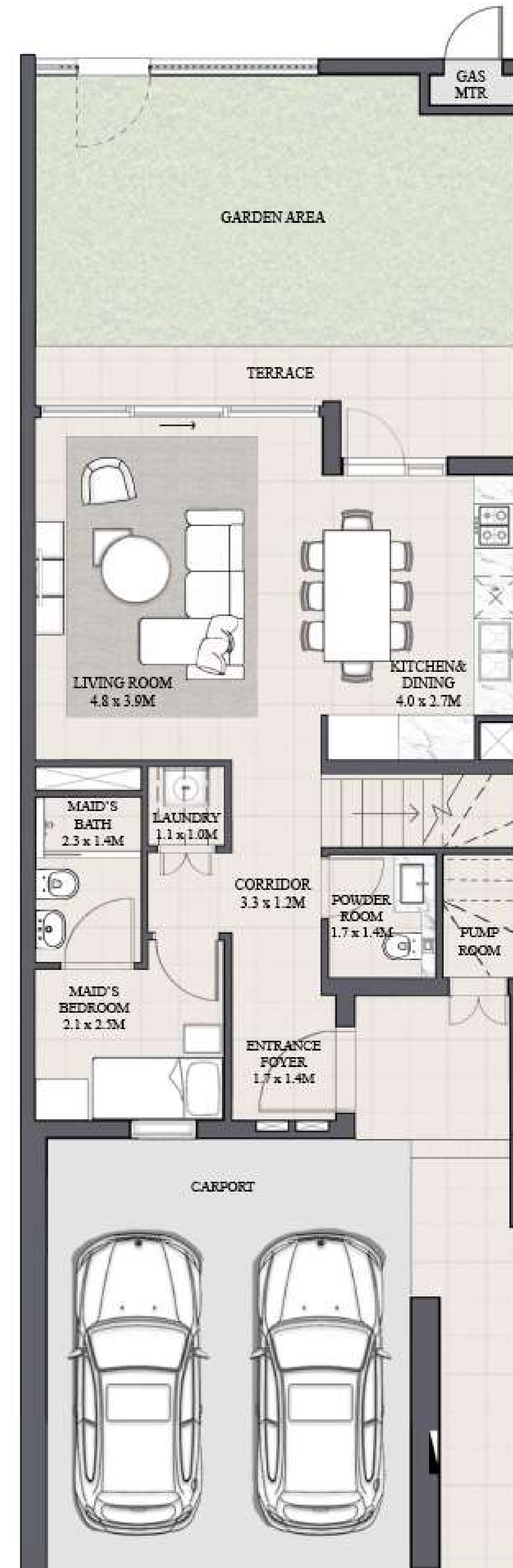

GROUND FLOOR

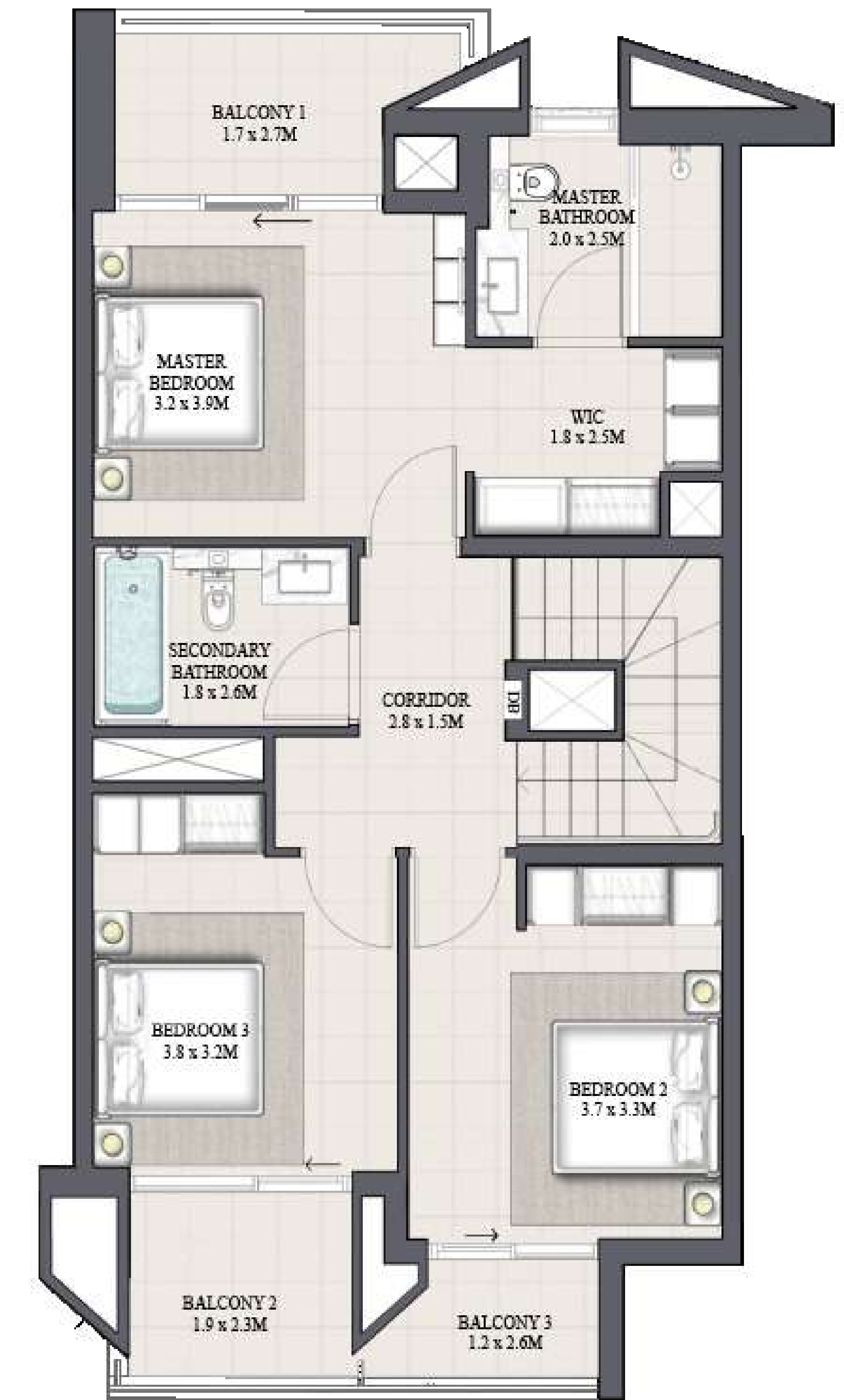

FIRST FLOOR

FLOOR PLAN 1. All dimensions are in imperial and metric, and measured from finish to finish excluding construction tolerances. 2. All materials, dimensions, and drawings are approximate only. 3. Information is subject to change without notice, at developer's absolute discretion. 4. Actual area may vary from the stated area. 5. Drawings not to scale. 6. All images used are for illustrative purposes only and do not represent the actual size, features, specifications, fittings, and furnishings. 7. The developer reserves the right to make revisions / alterations, at it's absolute discretion, without any liability whatsoever.

ANYA

ARABIAN RANCHES III

CONTEMPORARY TOWNHOUSE 3 BEDROOM 7

UNIT	TOTAL AREA	
8 PLEX - TH05	1912.21 SQFT	177.65 SQM

KEY PLAN

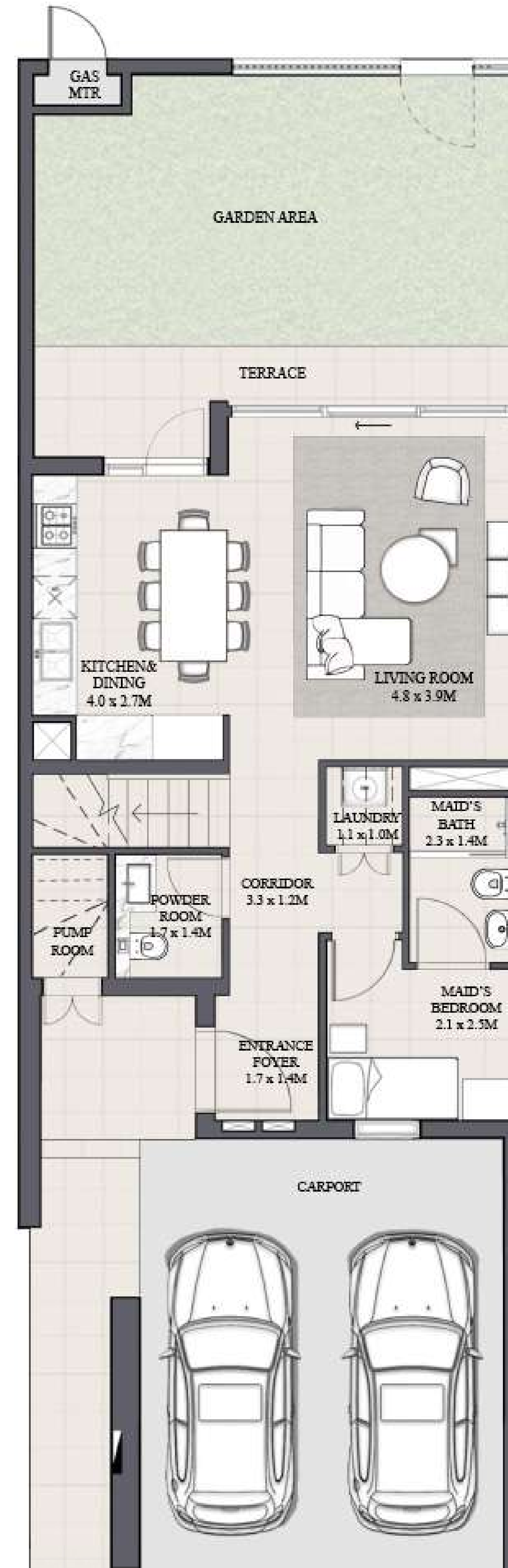

GROUND FLOOR



FIRST FLOOR

FLOOR PLAN 1. All dimensions are in imperial and metric, and measured from finish to finish excluding construction tolerances. 2. All materials, dimensions, and drawings are approximate only. 3. Information is subject to change without notice, at developer's absolute discretion. 4. Actual area may vary from the stated area. 5. Drawings not to scale. 6. All images used are for illustrative purposes only and do not represent the actual size, features, specifications, fittings, and furnishings. 7. The developer reserves the right to make revisions / alterations, at its absolute discretion, without any liability whatsoever.