

أهلاً ميدتاون...
أهلاً بالحياة!

HELLO MIDTOWN...
HELLO LIFE!

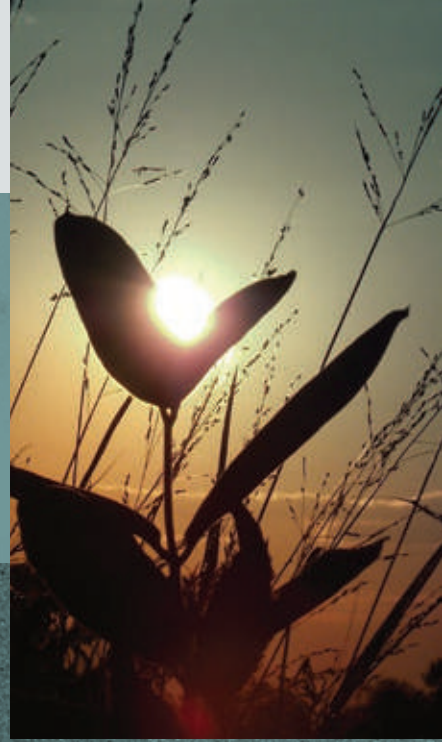

NOOR

M
MIDTOWN
BY DEYAAR

نور 3
استديو - نموذج B & C
NOOR 3
STUDIO APARTMENT - TYPE B & C

ST/B

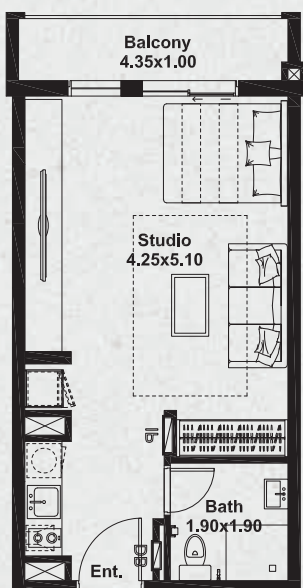

ST/C

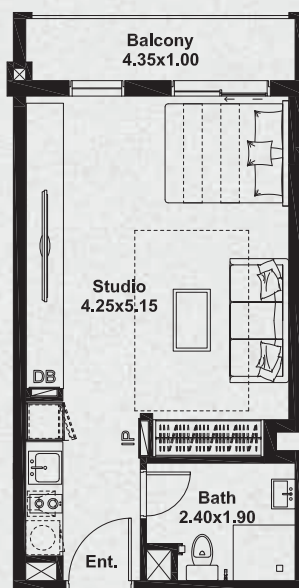

TYPE	LEVEL	UNIT (SQ.FT)	BALCONY (SQ.FT)	TOTAL (SQ.FT)
ST/B	9-16	380	56	436
ST/C	9-16	384	56	440

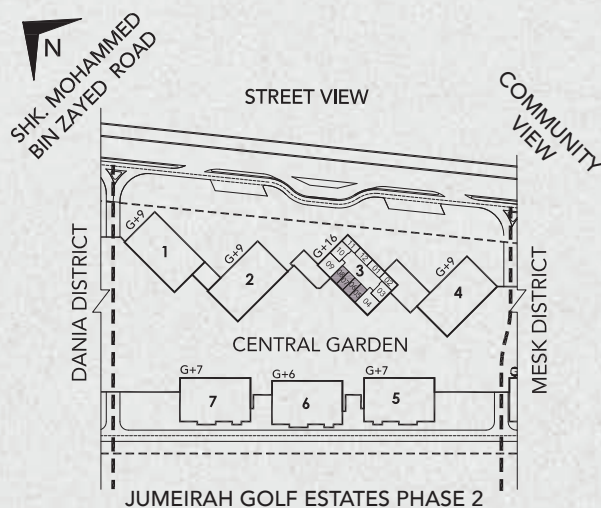

NOOR 3

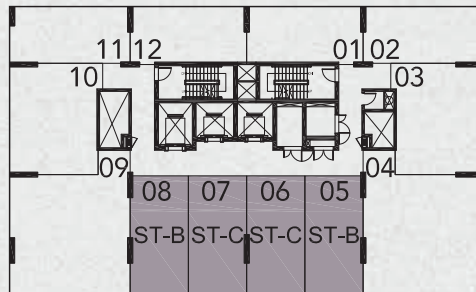

LEVEL 10-16

NOOR 3

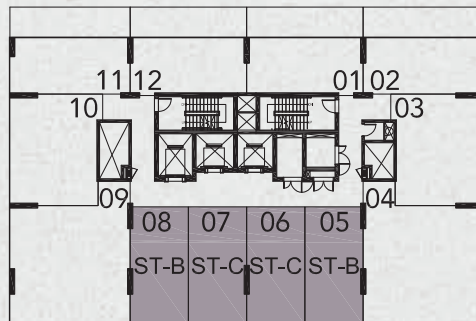

LEVEL 9

نور 3
استديو - نموذج D & E
NOOR 3
STUDIO APARTMENT - TYPE D & E

ST/D

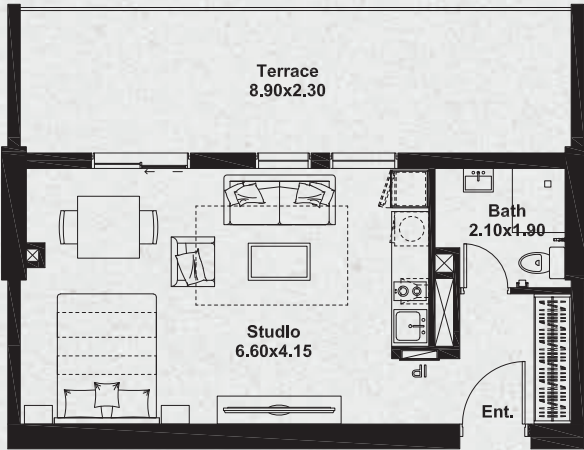

ST/E

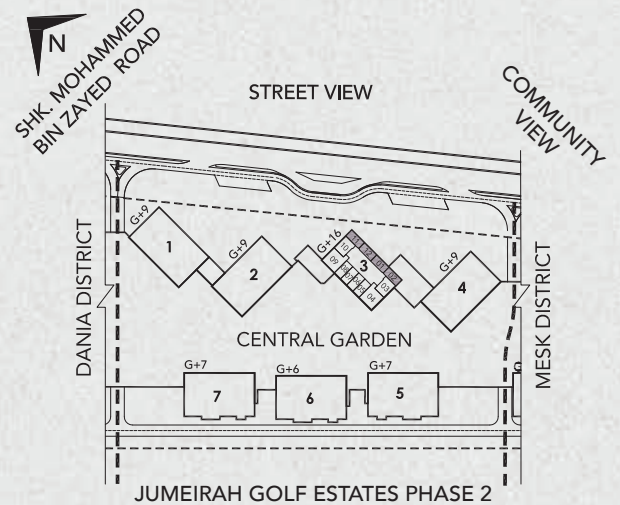
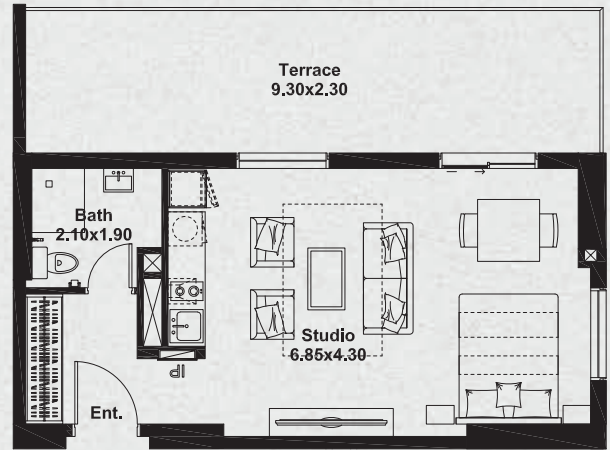

TYPE	LEVEL	UNIT (SQ.FT)	BALCONY (SQ.FT)	TOTAL (SQ.FT)
ST/D	9	427	240	667
ST/E	9	443	248	691

NOOR 3

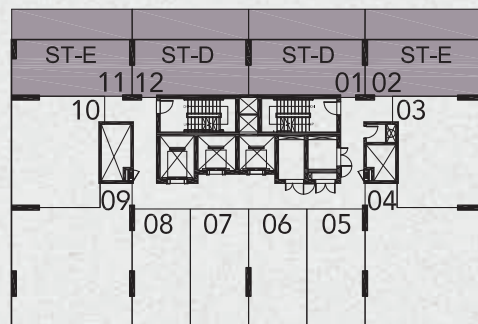

LEVEL 9

نور 3
استديو - نموذج F & G
NOOR 3
STUDIO APARTMENT - TYPE F & G

ST/F

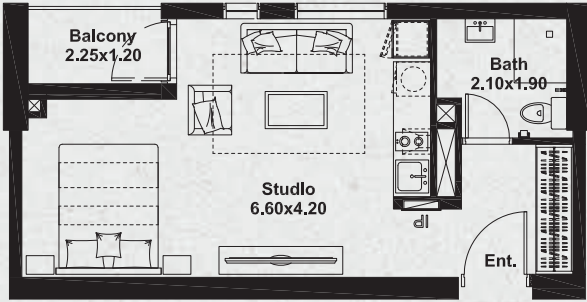

ST/G

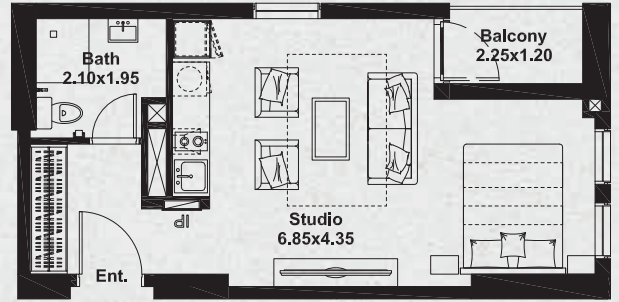

TYPE	LEVEL	UNIT (SQ.FT)	BALCONY (SQ.FT)	TOTAL (SQ.FT)
ST/F	10-16	394	37	431
ST/G	10-16	406	37	443

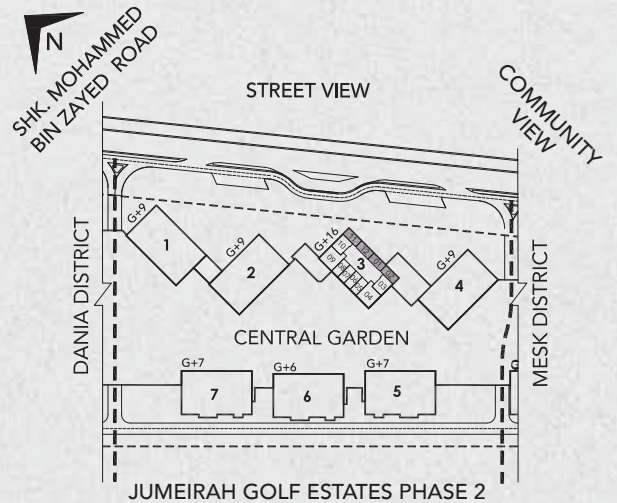

NOOR 3

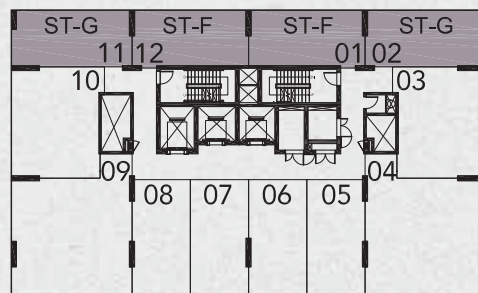

LEVEL 10-16

نور 1, 2, 3 & 4
استديو - نموذج H
NOOR 1, 2, 3 & 4
STUDIO APARTMENT - TYPE H

ST/H

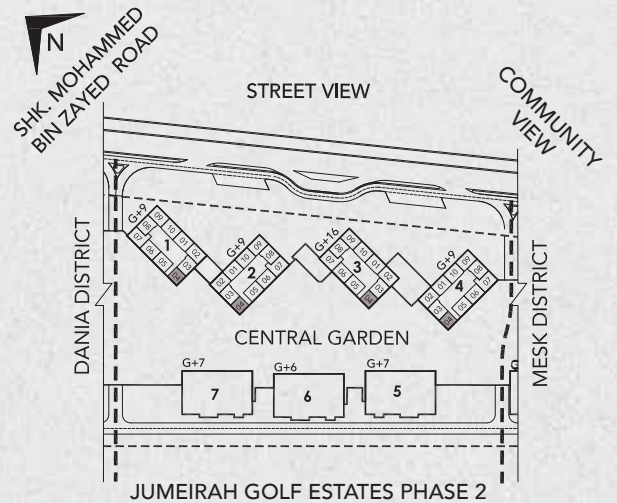
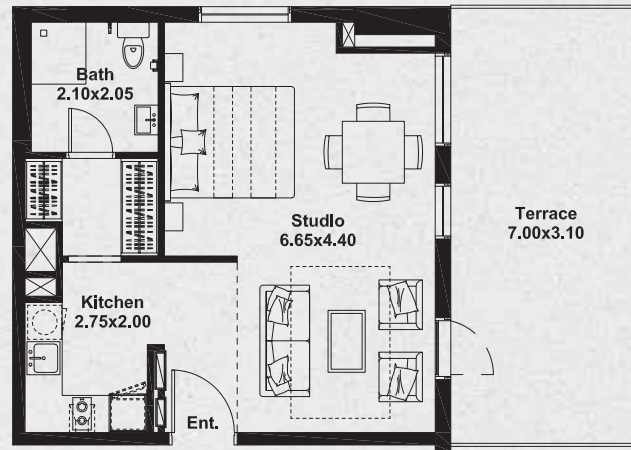

TYPE	LEVEL	UNIT (SQ.FT)	BALCONY (SQ.FT)	TOTAL (SQ.FT)
ST/H	1	486	246	732

NOOR 3

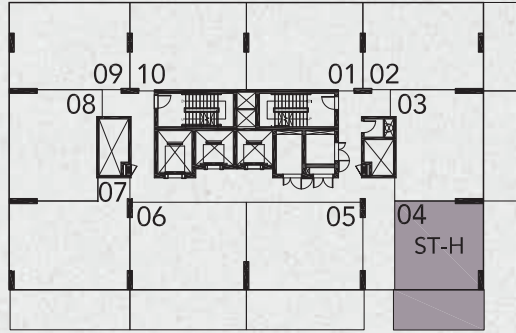

LEVEL 1

NOOR 2 & 4

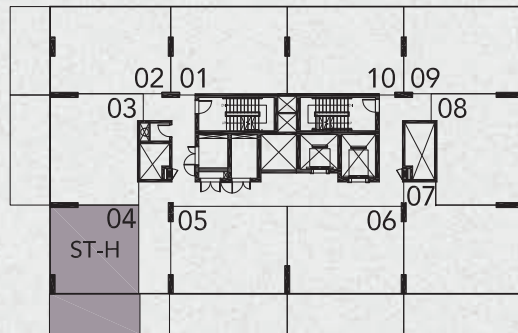

LEVEL 1

NOOR 1

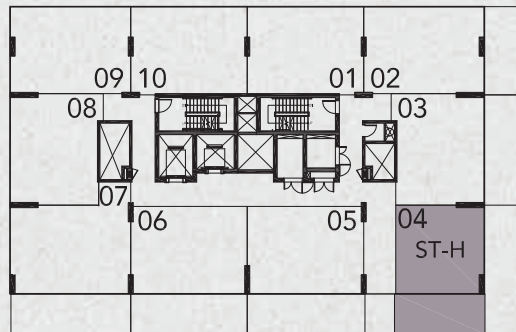

LEVEL 1

نور 1, 2, 3 & 4
شقة مكونة من غرفة نوم واحدة - نموذج A
NOOR 1, 2, 3 & 4
ONE BEDROOM APARTMENT - TYPE A

1BR/A

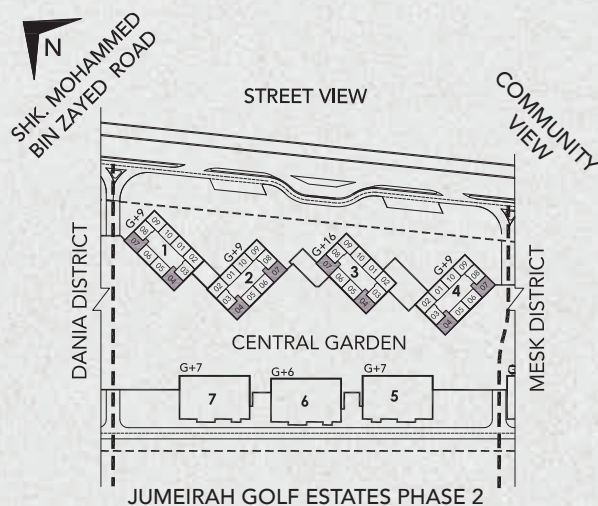
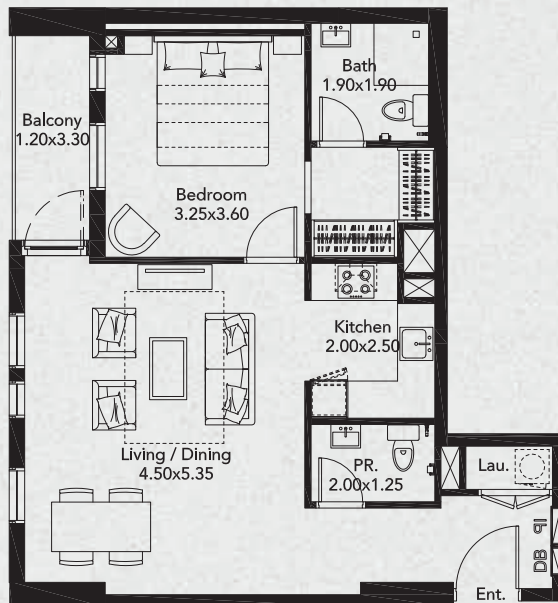

TYPE	LEVEL	UNIT (SQ.FT)	BALCONY (SQ.FT)	TOTAL (SQ.FT)
1BR/A	2-9	682	53	735

NOOR 3

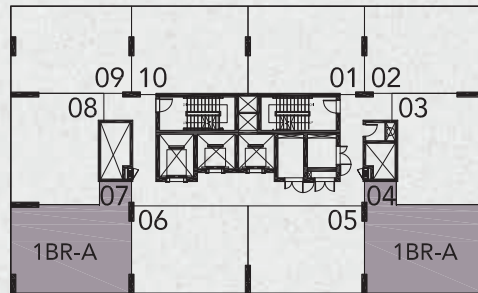

LEVEL 2-8

NOOR 2 & 4

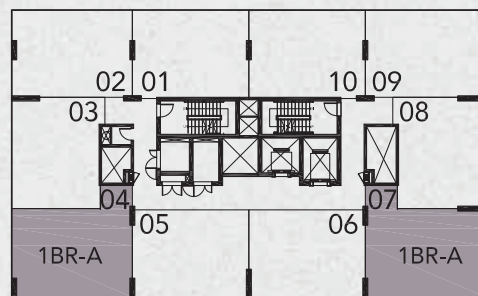

LEVEL 2-9

NOOR 1

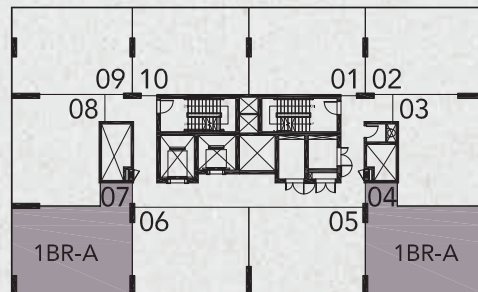

LEVEL 2-9

نور 1, 2, 3 & 4
شقة مكونة من غرفة نوم واحدة - نموذج B
NOOR 1, 2, 3 & 4
ONE BEDROOM APARTMENT - TYPE B

1BR/B

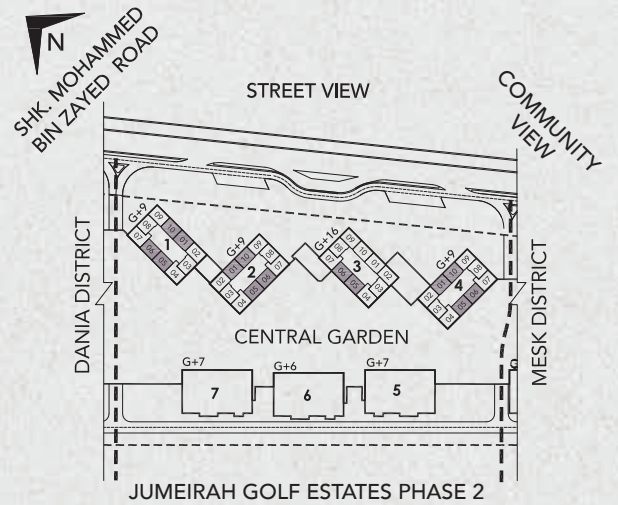
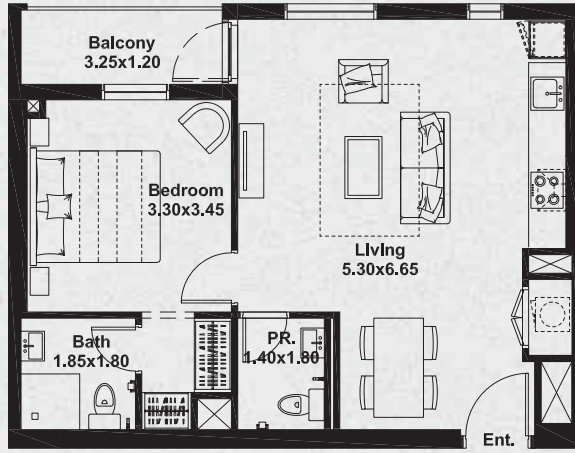

TYPE	LEVEL	UNIT (SQ.FT)	BALCONY (SQ.FT)	TOTAL (SQ.FT)
1BR/B	1-9	607	51	658
	2-9	586	51	637

NOOR 2 & 4

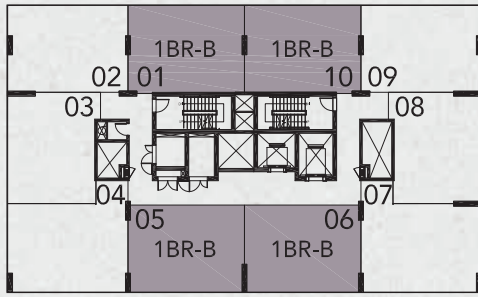

LEVEL 2-9

NOOR 2 & 4

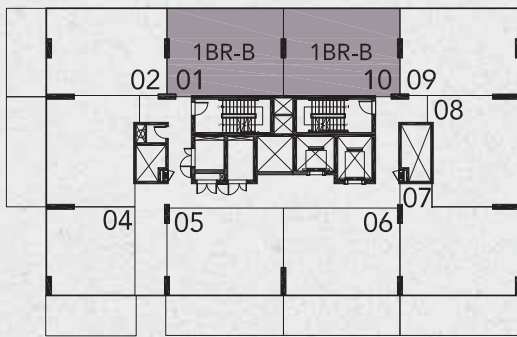

LEVEL 1

NOOR 1

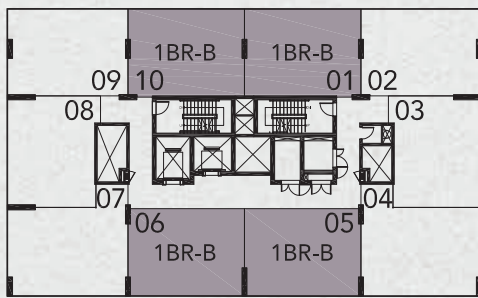

LEVEL 2-9

NOOR 1

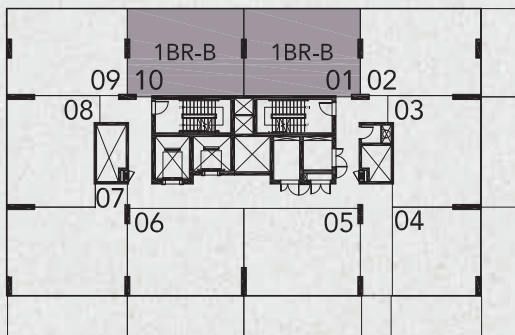

LEVEL 1

NOOR 3

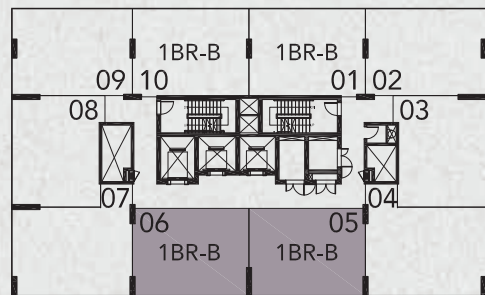

LEVEL 2-8

نور 3

شقة مكونة من غرفة نوم واحدة - نموذج *B

NOOR 3

ONE BEDROOM APARTMENT - TYPE B*

1BR/B*

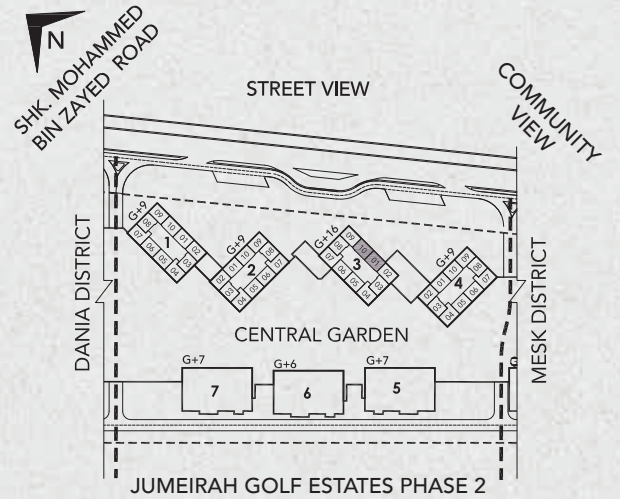
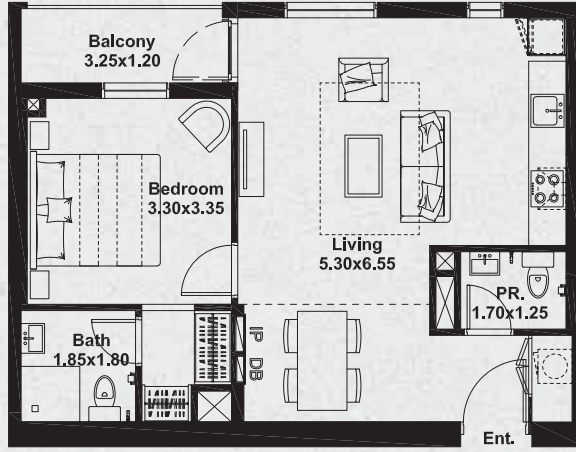

TYPE	LEVEL	UNIT (SQ.FT)	BALCONY (SQ.FT)	TOTAL (SQ.FT)
1BR/B*	1-8	610	51	661

NOOR 3

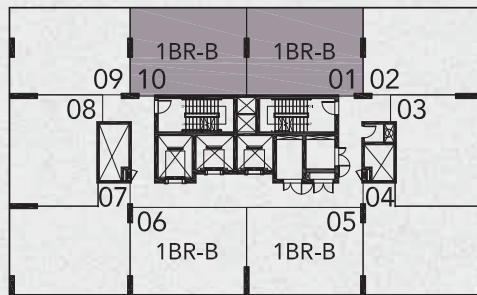

LEVEL 2-8

NOOR 3

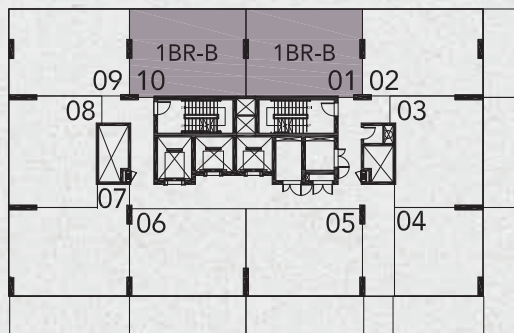

LEVEL 1

نور 1, 2, 3 & 4
شقة مكونة من غرفة نوم واحدة - نموذج C
NOOR 1, 2, 3 & 4
ONE BEDROOM APARTMENT - TYPE C

1BR/C

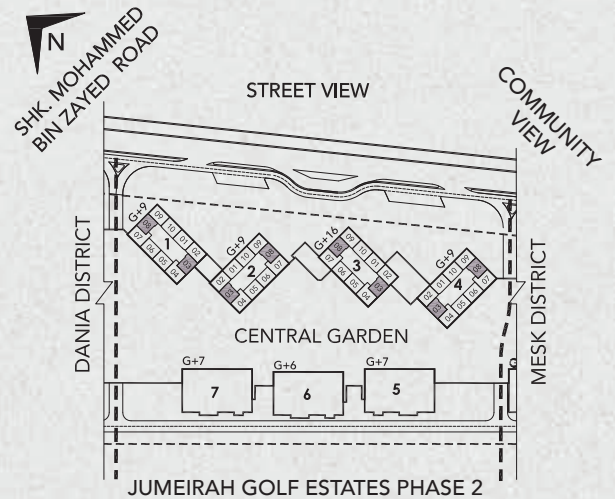
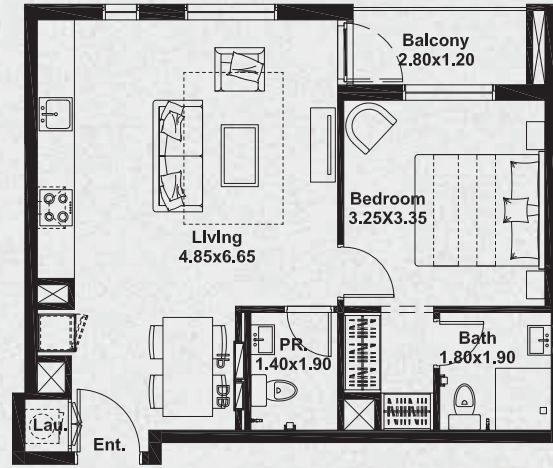

TYPE	LEVEL	UNIT (SQ.FT)	BALCONY (SQ.FT)	TOTAL (SQ.FT)
1BR/C	1-16	578	43	621

NOOR 2 & 4

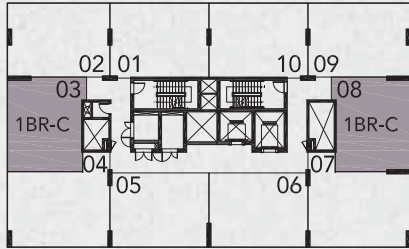

LEVEL 2-9

NOOR 3

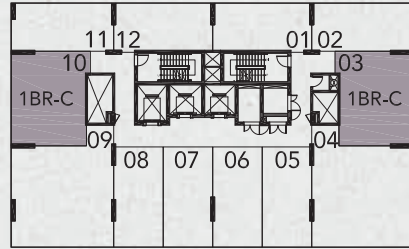

LEVEL 10-16

NOOR 2 & 4

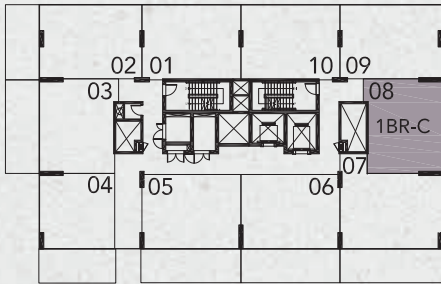

LEVEL 1

NOOR 3

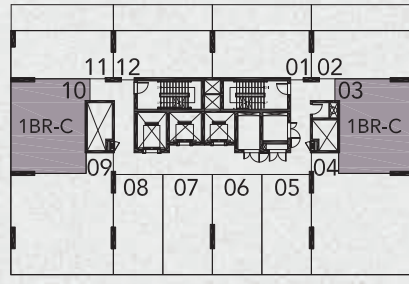

LEVEL 9

NOOR 1

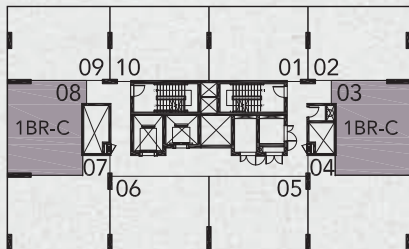

LEVEL 2-9

NOOR 3

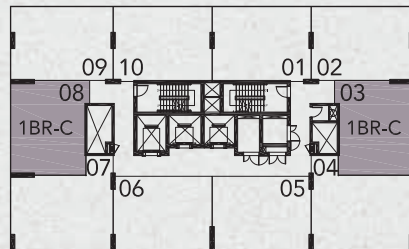

LEVEL 2-8

NOOR 1

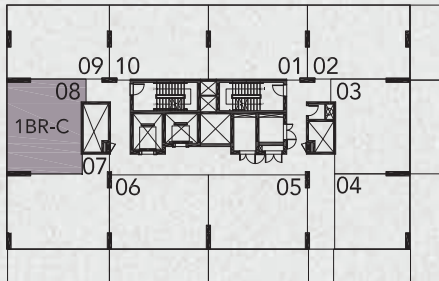

LEVEL 1

NOOR 3

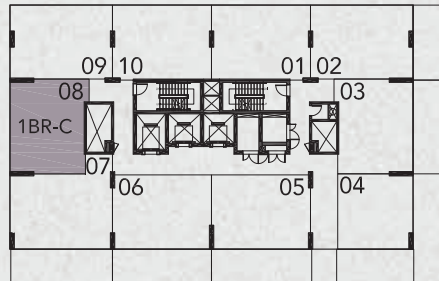

LEVEL 1

نور 1, 2, 3 & 4
شقة مكونة من غرفة نوم واحدة - نموذج C1
NOOR 1, 2, 3 & 4
ONE BEDROOM APARTMENT - TYPE C1

1BR/C1

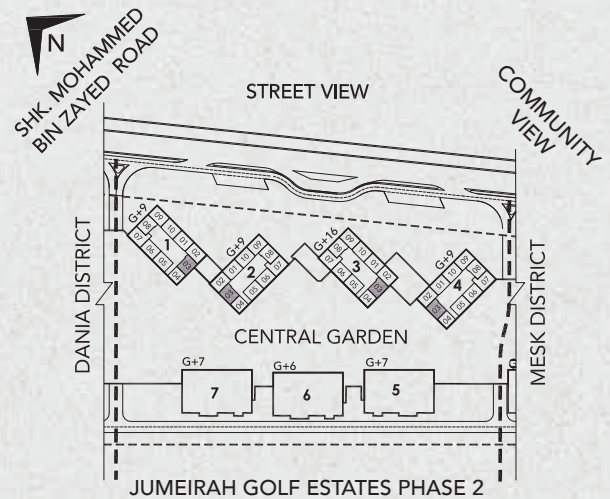
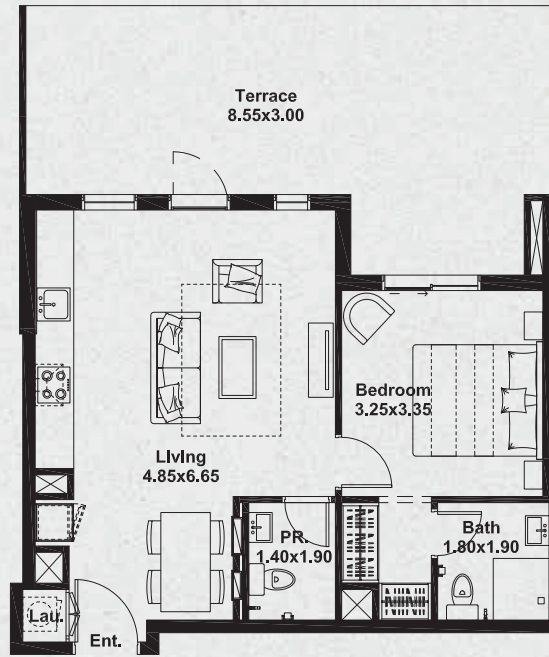

TYPE	LEVEL	UNIT (SQ.FT)	BALCONY (SQ.FT)	TOTAL (SQ.FT)
1BR/C1	1	578	337	915

NOOR 3

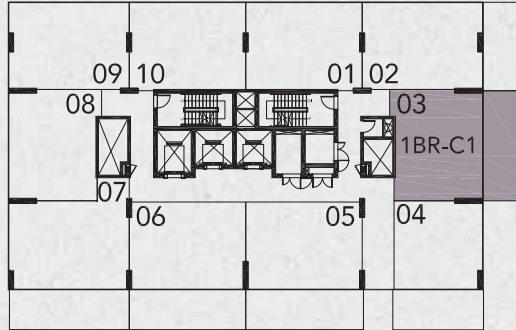

LEVEL 1

NOOR 2 & 4

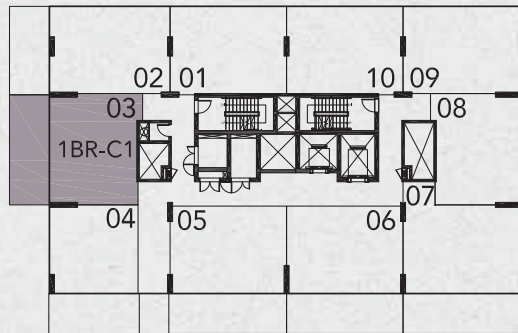

LEVEL 1

NOOR 1

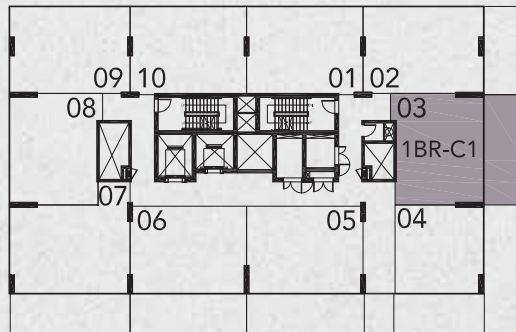

LEVEL 1

نور 1, 2, 3 & 4
شقة مكونة من غرفة نوم واحدة - نموذج D
NOOR 1, 2, 3 & 4
ONE BEDROOM APARTMENT - TYPE D

1BR/D

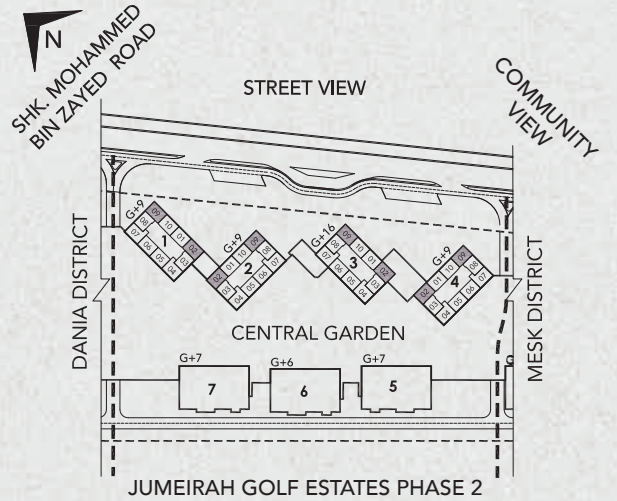
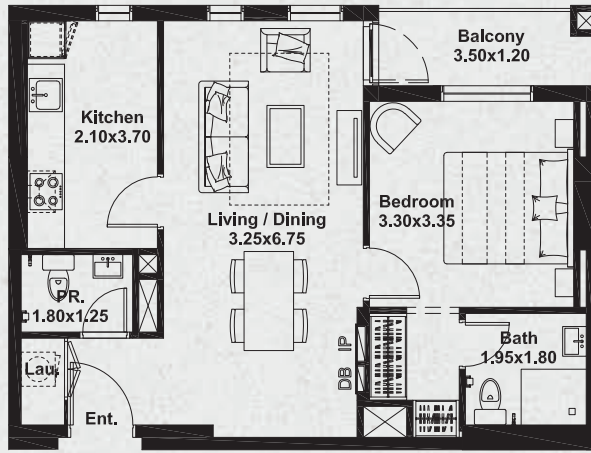

TYPE	LEVEL	UNIT (SQ.FT)	BALCONY (SQ.FT)	TOTAL (SQ.FT)
1BR/D	1-9	628	52	680

NOOR 2 & 4

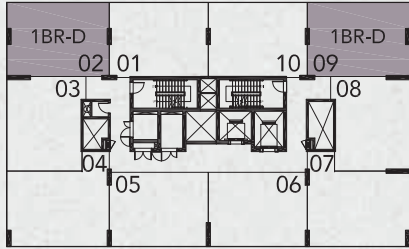

LEVEL 2-9

NOOR 2 & 4

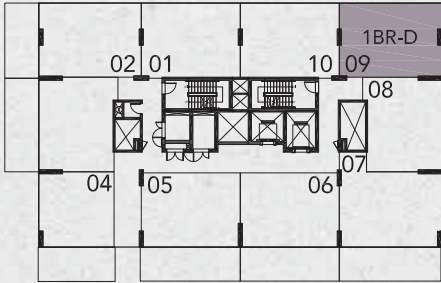

LEVEL 1

NOOR 1

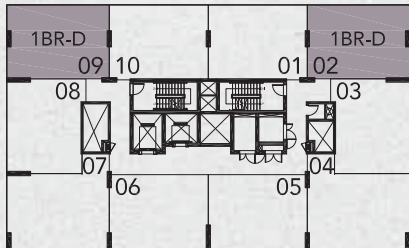

LEVEL 2-9

NOOR 3

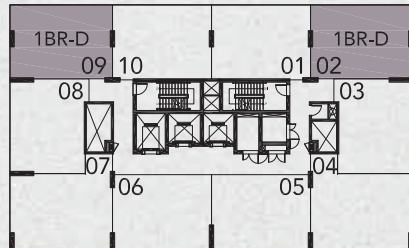

LEVEL 2-8

NOOR 1

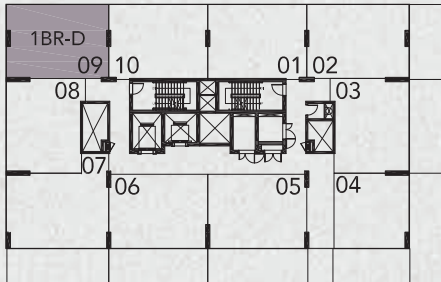

LEVEL 1

NOOR 3

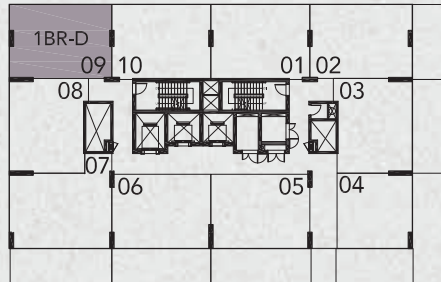

LEVEL 1

نور 1, 2, 3 & 4
شقة مكونة من غرفة نوم واحدة - نموذج D1
NOOR 1, 2, 3 & 4
ONE BEDROOM APARTMENT - TYPE D1

1BR/D1

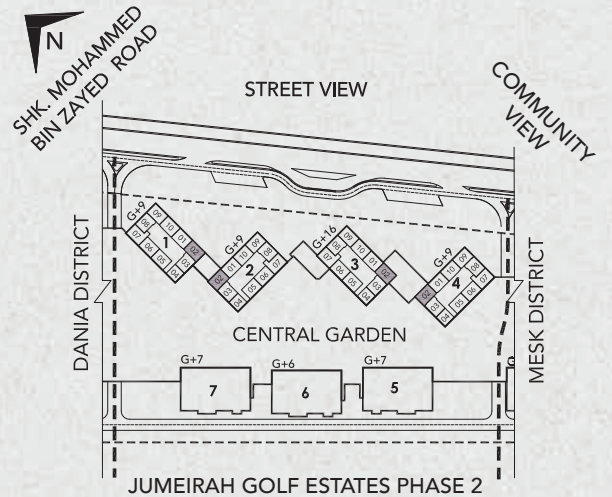
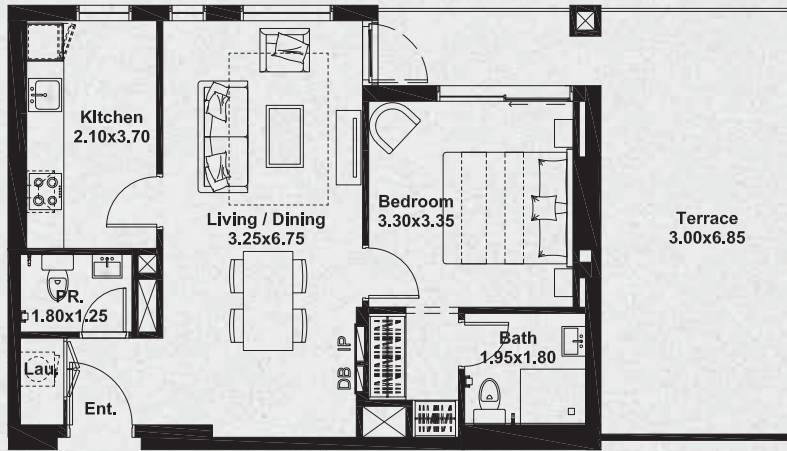

TYPE	LEVEL	UNIT (SQ.FT)	BALCONY (SQ.FT)	TOTAL (SQ.FT)
1BR/D1	1	628	288	916

NOOR 3

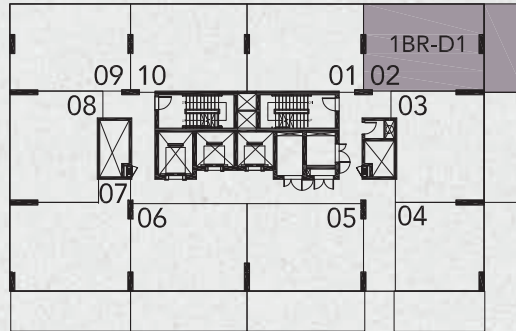

LEVEL 1

NOOR 2 & 4

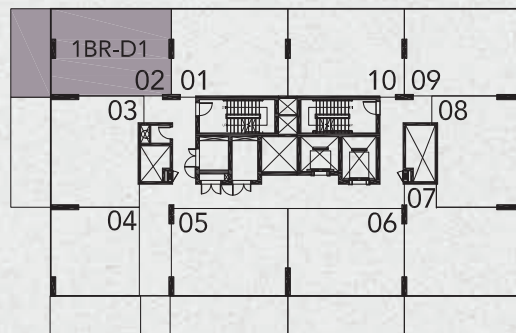

LEVEL 1

NOOR 1

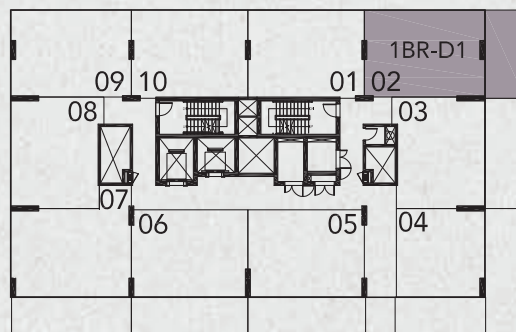

LEVEL 1

نور 1, 2, 3 & 4
شقة مكونة من غرفة نوم واحدة - نموذج E
NOOR 1, 2, 3 & 4
ONE BEDROOM APARTMENT - TYPE E

1BR/E

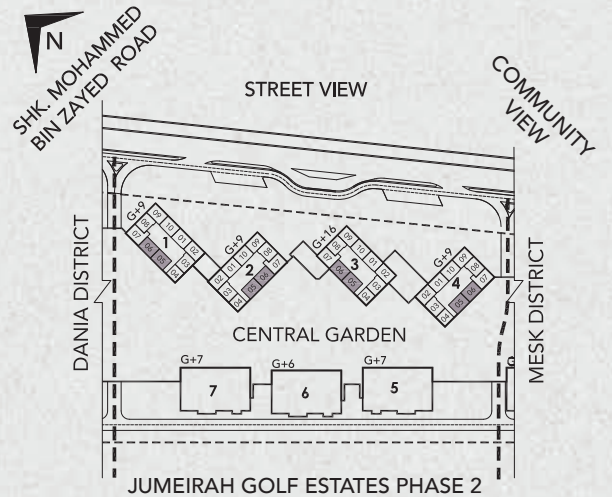
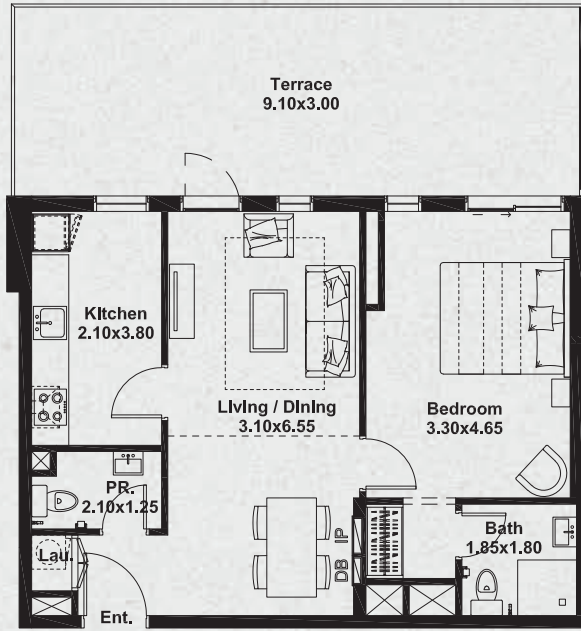

TYPE	LEVEL	UNIT (SQ.FT)	BALCONY (SQ.FT)	TOTAL (SQ.FT)
1BR/E	1	636	313	949
	1	636	317	953

NOOR 3

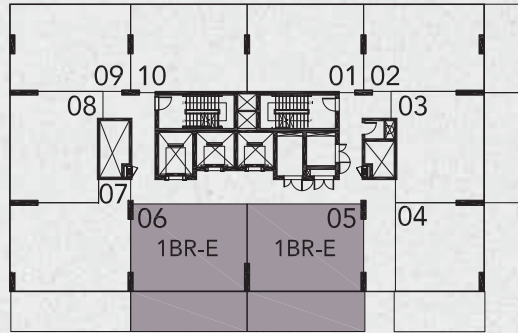

LEVEL 1

NOOR 2 & 4

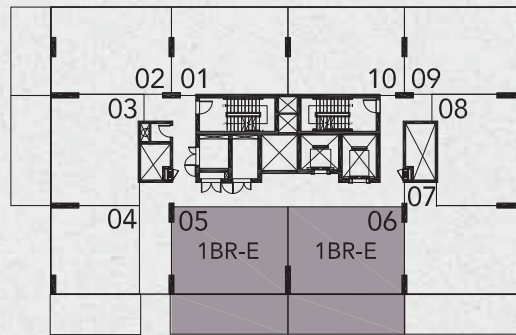

LEVEL 1

NOOR 1

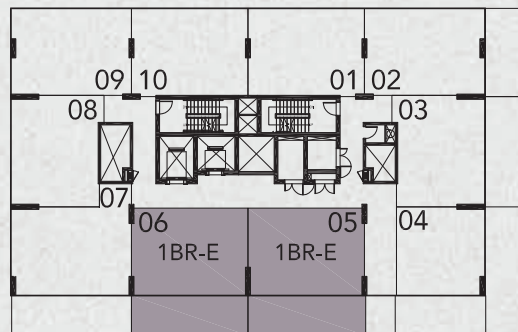

LEVEL 1

شقة مكونة من غرفة نوم واحدة - نموذج F
NOOR 1, 2, 3 & 4
ONE BEDROOM APARTMENT - TYPE F

1BR/F

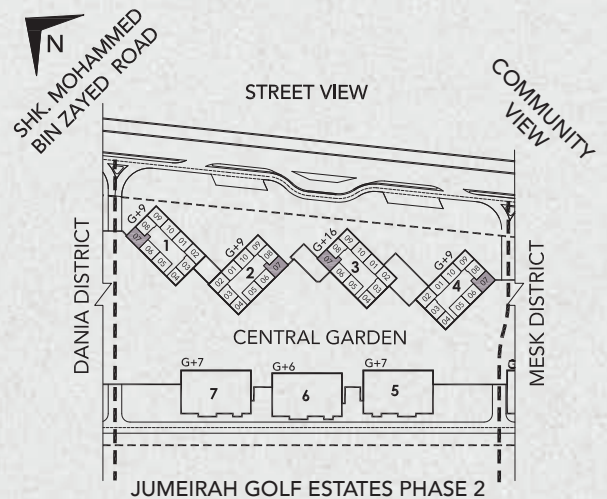
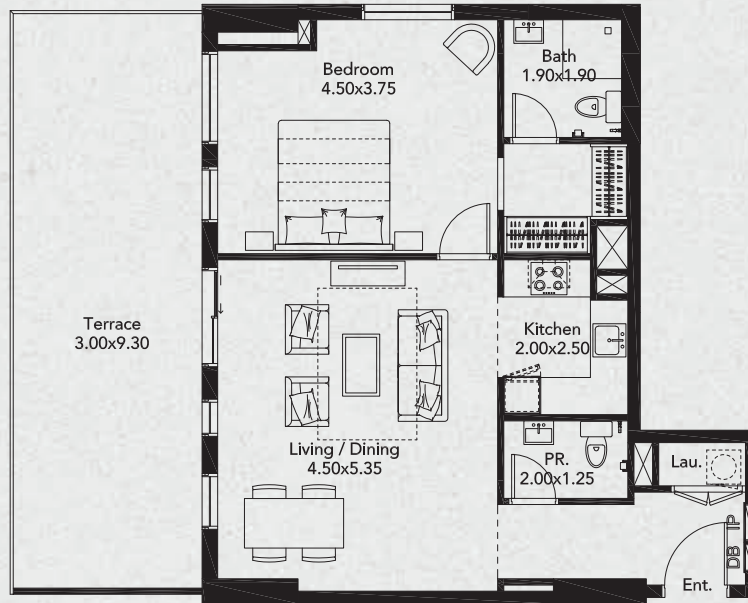

TYPE	LEVEL	UNIT (SQ.FT)	BALCONY (SQ.FT)	TOTAL (SQ.FT)
1BR/F	1	726	322	1,048

NOOR 3

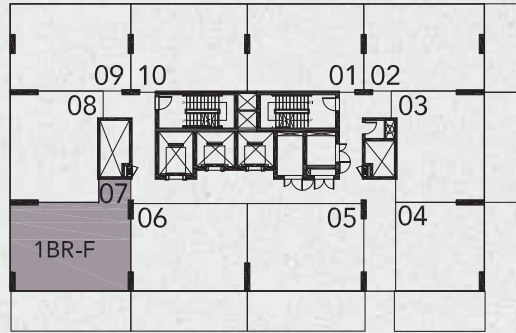

LEVEL 1

NOOR 2 & 4

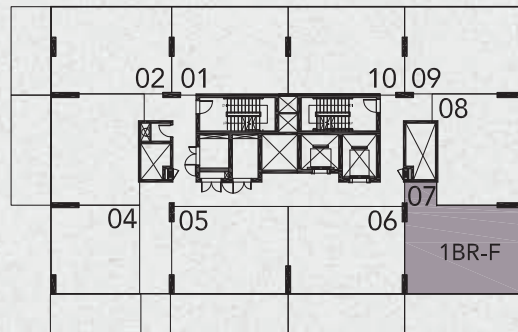

LEVEL 1

NOOR 1

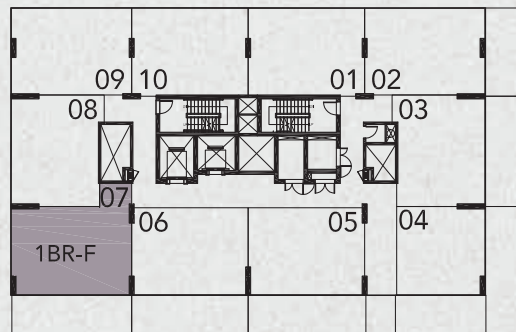

LEVEL 1

نور 5, 6 & 7
شقة مكونة من غرفة نوم واحدة - نموذج G
NOOR 5, 6 & 7
ONE BEDROOM APARTMENT - TYPE G

1BR/G

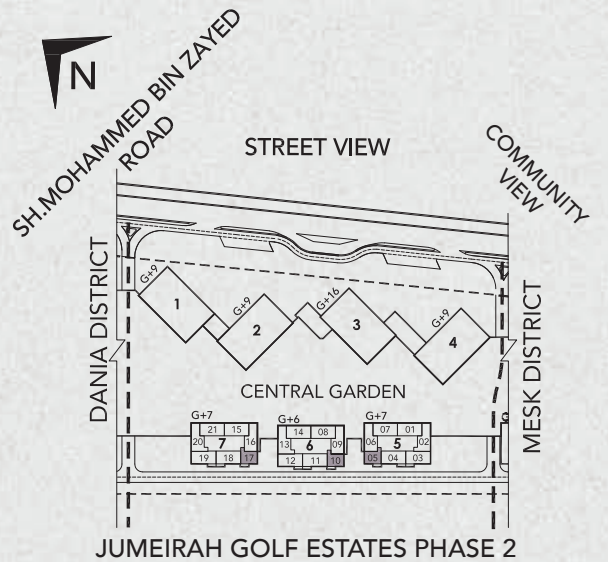
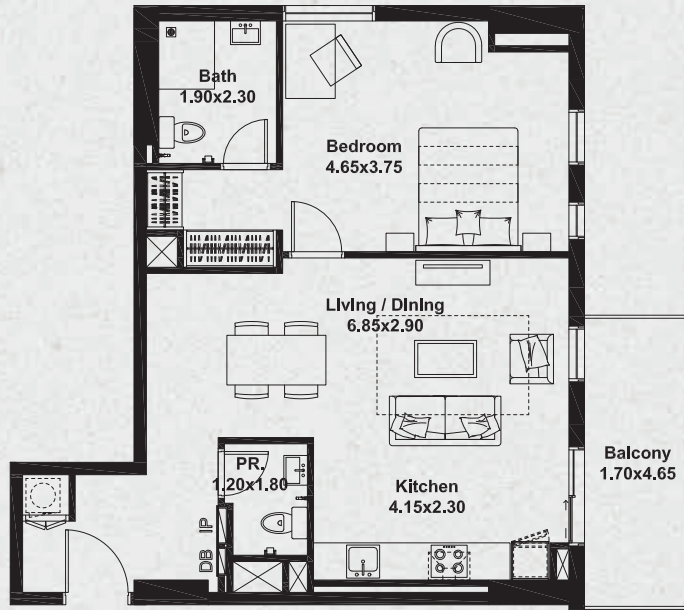

TYPE	LEVEL	UNIT (SQ.FT)	BALCONY (SQ.FT)	TOTAL (SQ.FT)
1BR/G	2-4	737	95	832

LEVEL 2-4

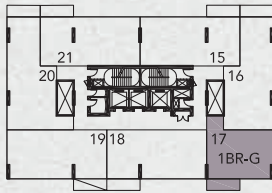

NOOR 7

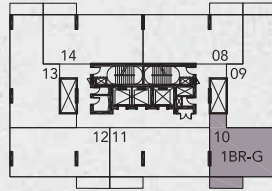

NOOR 6

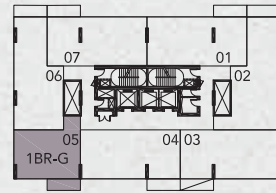

NOOR 5

نور 5, 6 & 7
شقة مكونة من غرفة نوم واحدة - نموذج H
NOOR 5, 6 & 7
ONE BEDROOM APARTMENT - TYPE H

1BR/H

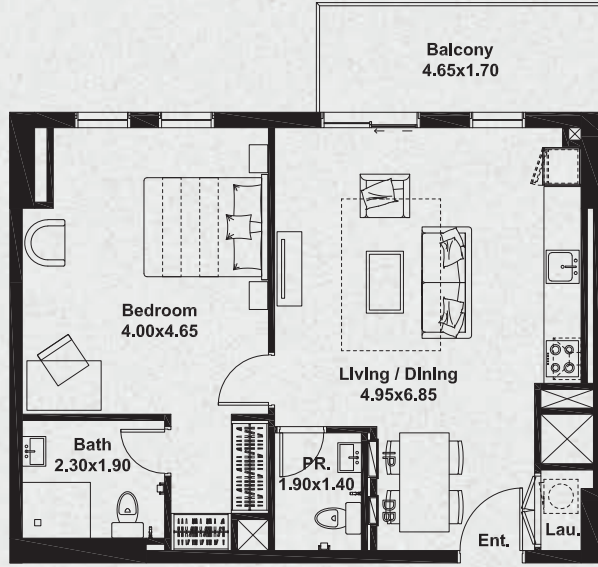

TYPE	LEVEL	UNIT (SQ.FT)	BALCONY (SQ.FT)	TOTAL (SQ.FT)
1BR/H	M	694	95	789
	1			
	5-6			
	7			

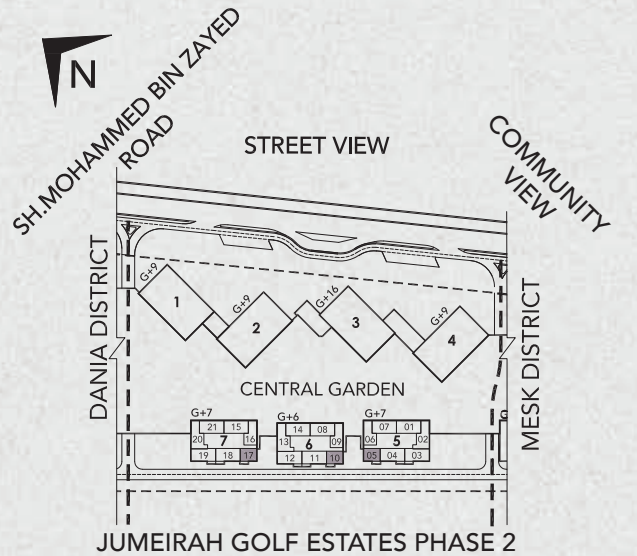

LEVEL 7



LEVEL 5-6

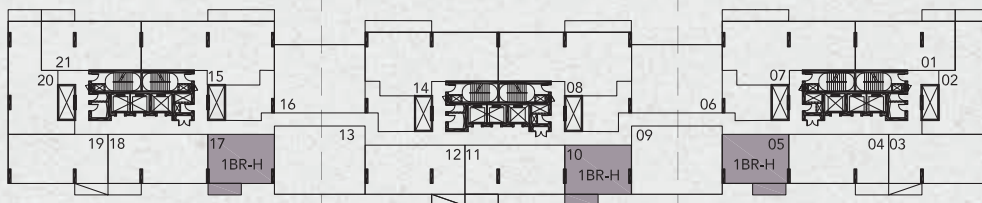

LEVEL 1

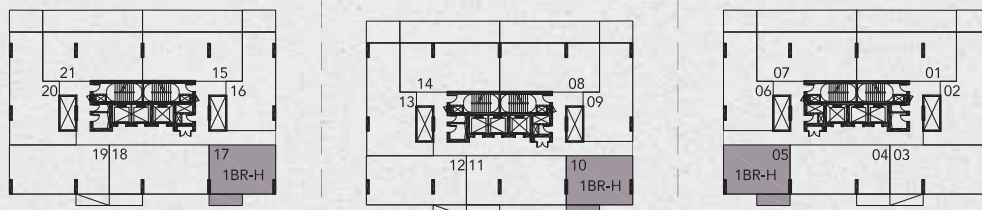

LEVEL M

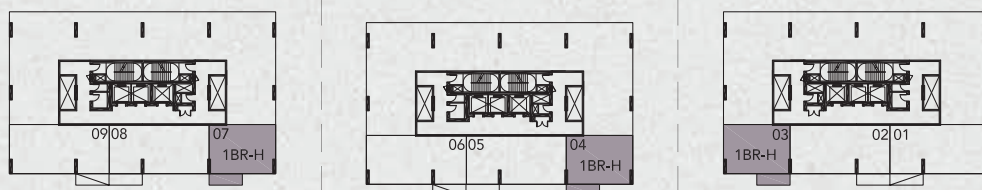

NOOR 7

NOOR 6

NOOR 5

شقة مكونة من غرفة نوم واحدة - نموذج 1
NOOR 5, 6 & 7
ONE BEDROOM APARTMENT - TYPE I

1BR/I

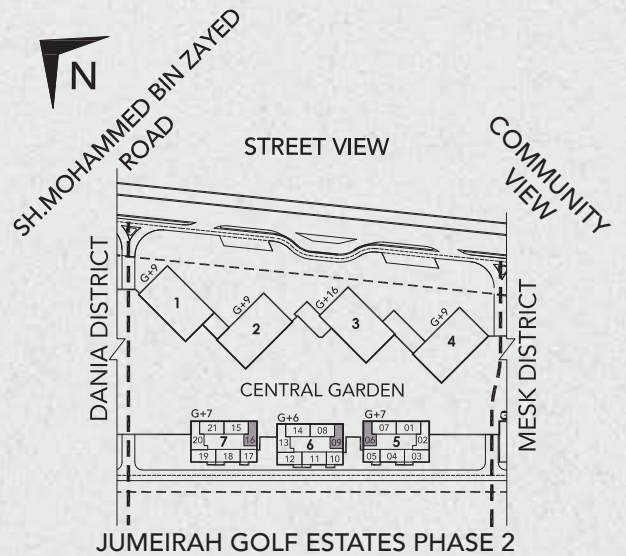
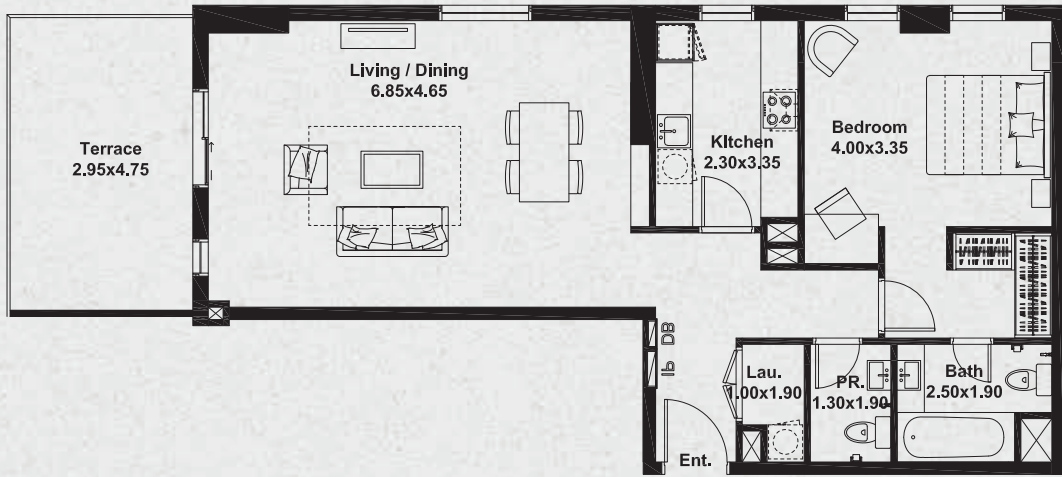

TYPE	LEVEL	UNIT (SQ.FT)	BALCONY (SQ.FT)	TOTAL (SQ.FT)
1BR/I	1	886	160	1,047

LEVEL 1

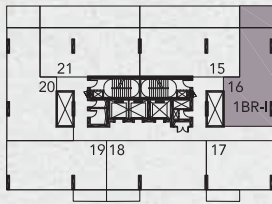

NOOR 7

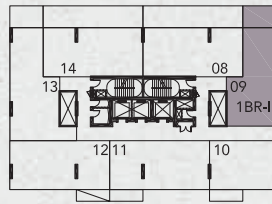

NOOR 6

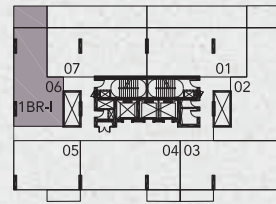

NOOR 5

نور 3
شقة مكونة من غرفتي نوم - نموذج A
NOOR 3
TWO BEDROOM APARTMENT - TYPE A

2BR/A

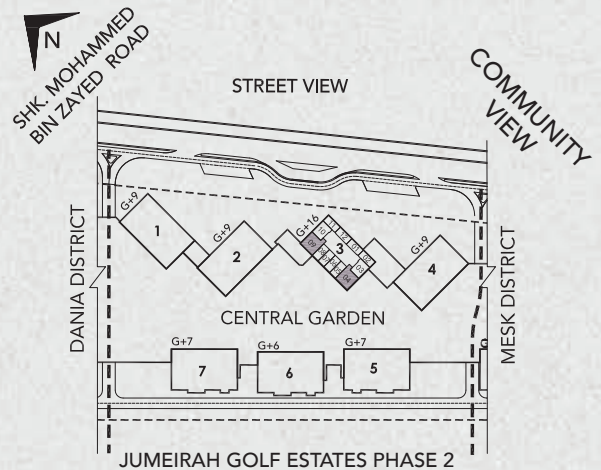
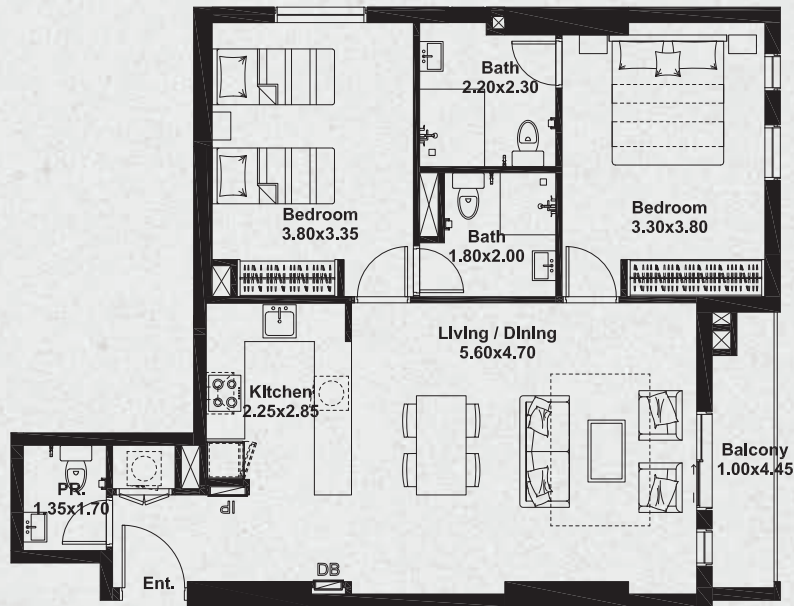

TYPE	LEVEL	UNIT (SQ.FT)	BALCONY (SQ.FT)	TOTAL (SQ.FT)
2BR/A	09-16	939	54	993

NOOR 3

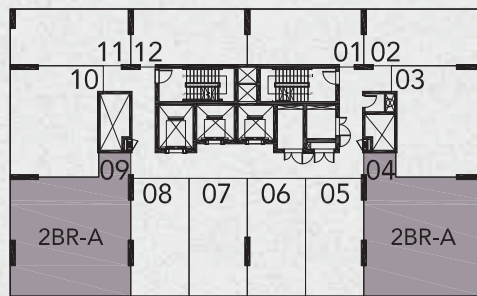

LEVEL 10-16

NOOR 3

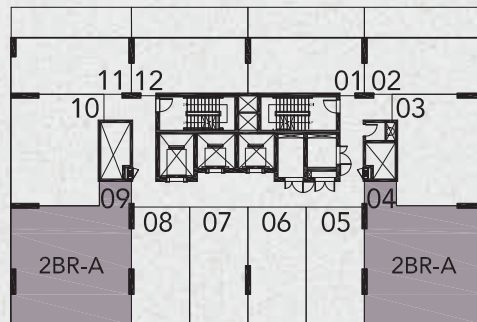

LEVEL 9

نور 5, 6 , 7 & 6
شقة مكونة من غرفتي نوم - نموذج B
NOOR 5, 6 & 7
TWO BEDROOM APARTMENT - TYPE B

2BR/B

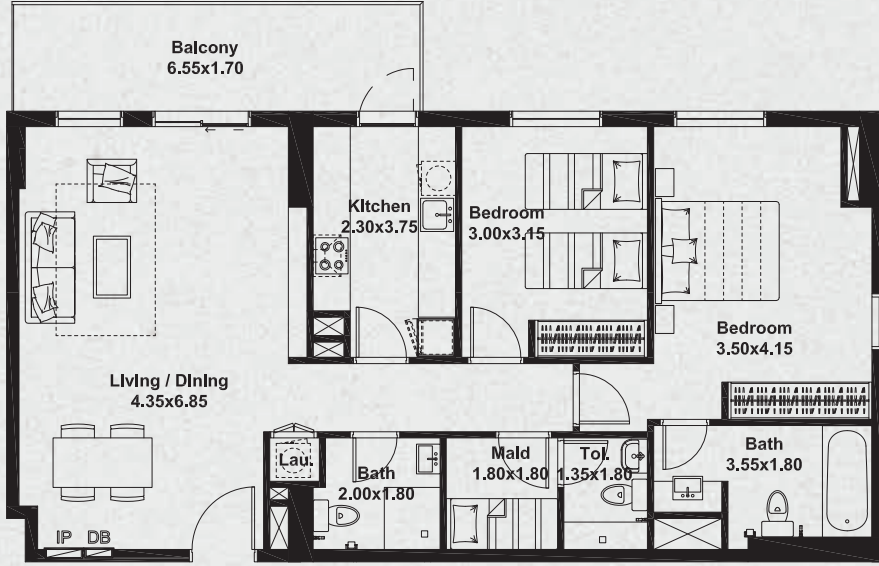

TYPE	LEVEL	UNIT (SQ.FT)	BALCONY (SQ.FT)	TOTAL (SQ.FT)
2BR/B	M	1,033	133	1,166
	1-4			
	5-6			
	7			

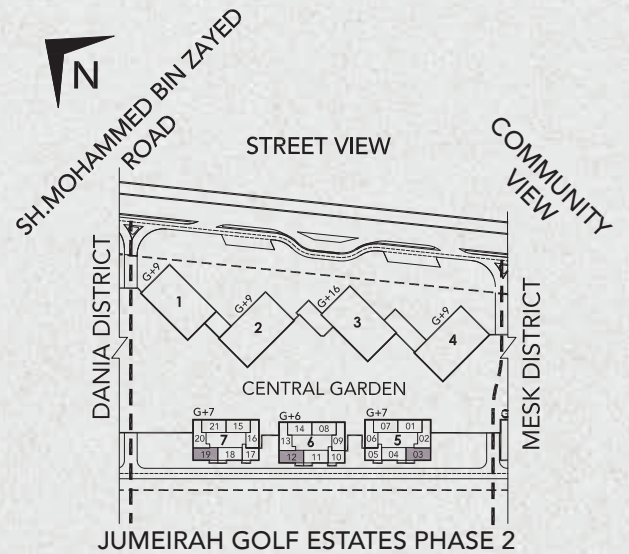

LEVEL 7

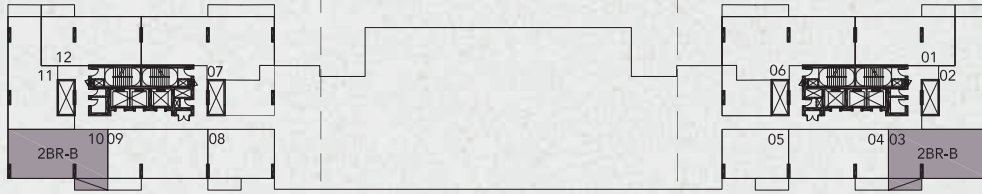

LEVEL 5-6

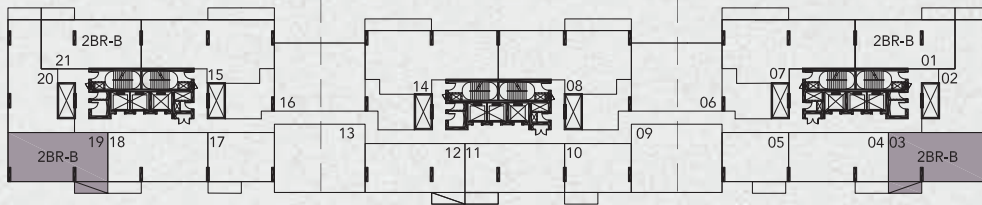

LEVEL 2-4

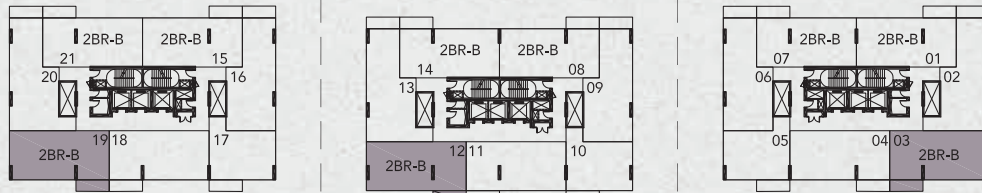

LEVEL 1

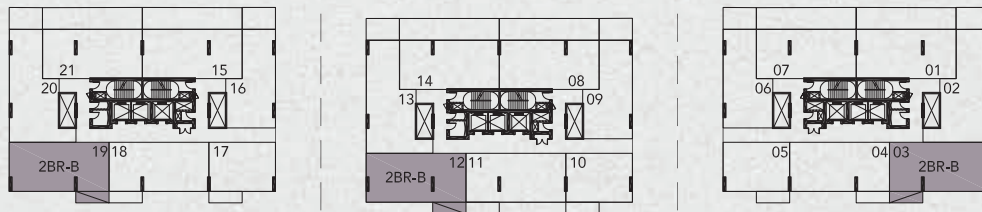

LEVEL M

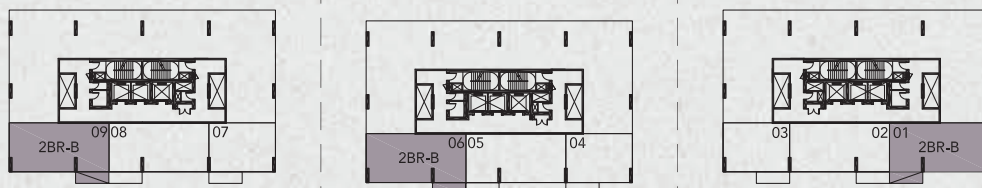

NOOR 7

NOOR 6

NOOR 5

نور 5, 6 & 7
شقة مكونة من غرفتي نوم - نموذج *B
NOOR 5, 6 & 7
TWO BEDROOM APARTMENT - TYPE B*

2BR/B*

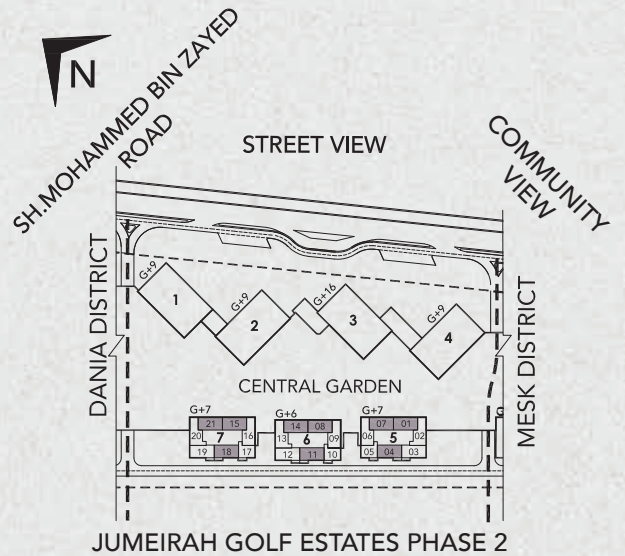
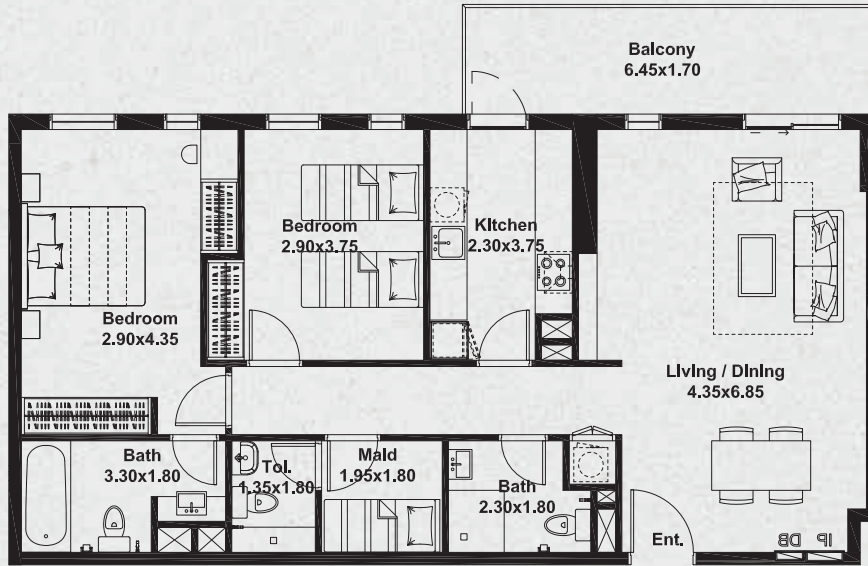

TYPE	LEVEL	UNIT (SQ.FT)	BALCONY (SQ.FT)	TOTAL (SQ.FT)
2BR/B*	M	1,032	133	1,165
	1-4			
	5-6			
	7	1,054	130	1,184
	2-4			
	5-6			
7				

LEVEL 7

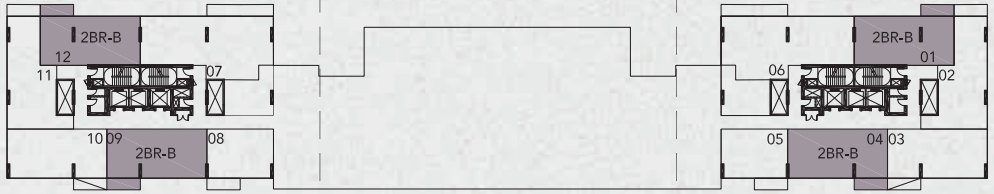

LEVEL 5-6

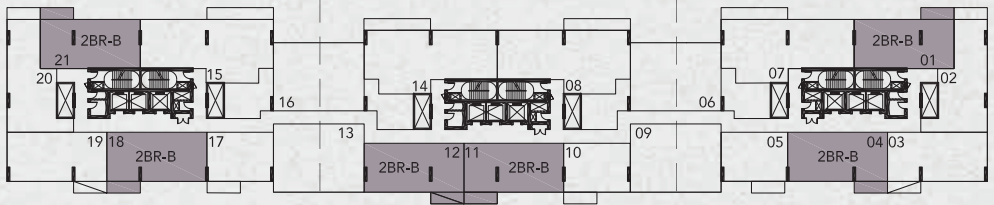

LEVEL 2-4

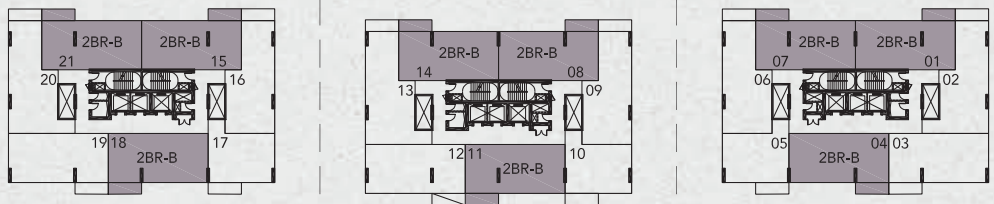

LEVEL 1

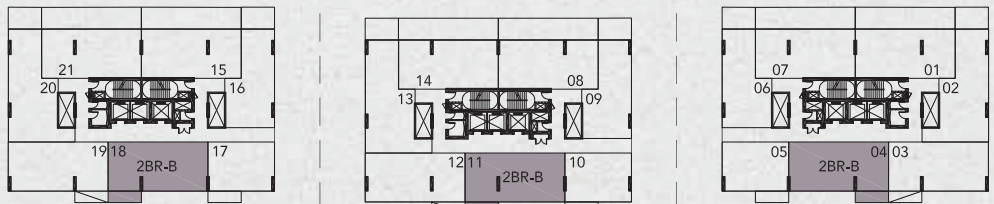

LEVEL M

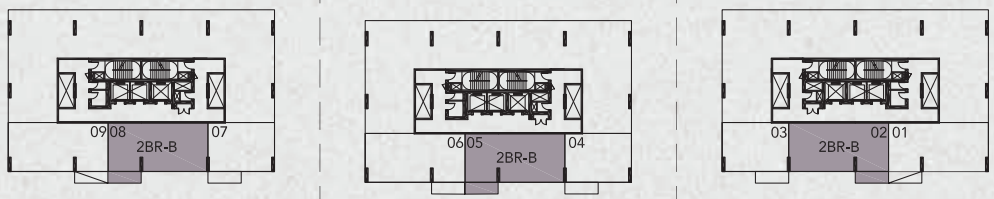

NOOR 7

NOOR 6

NOOR 5

نور 5, 6 & 7
شقة مكونة من غرفتي نوم - نموذج C
NOOR 5, 6 & 7
TWO BEDROOM APARTMENT - TYPE C

2BR/C

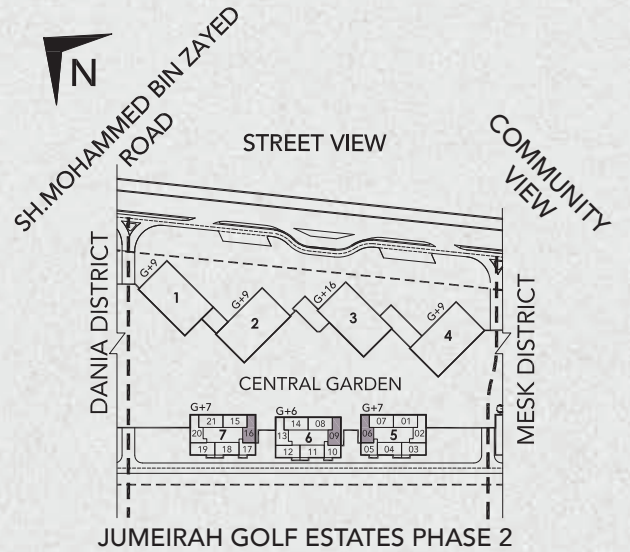
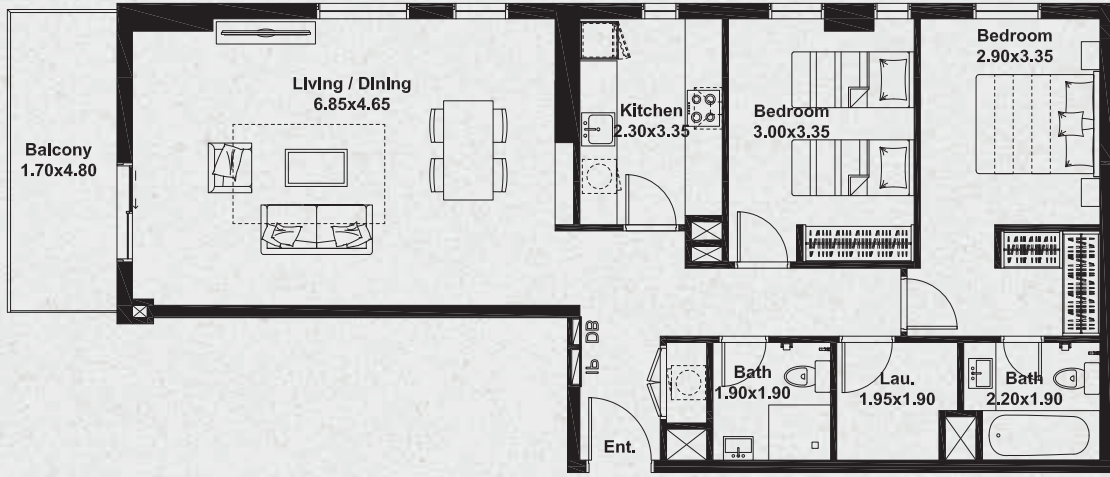

TYPE	LEVEL	UNIT (SQ.FT)	BALCONY (SQ.FT)	TOTAL (SQ.FT)
2BR/C	2-4	1,043	98	1,141

LEVEL 2-4

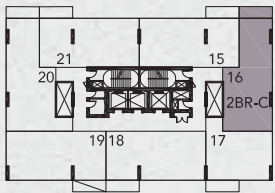

NOOR 7

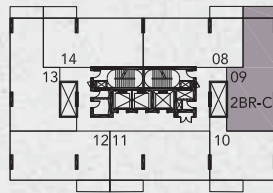

NOOR 6

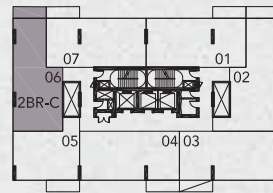

NOOR 5

نور 5, 6 & 7
شقة مكونة من غرفتي نوم - نموذج D
NOOR 5, 6 & 7
TWO BEDROOM APARTMENT - TYPE D

2BR/D

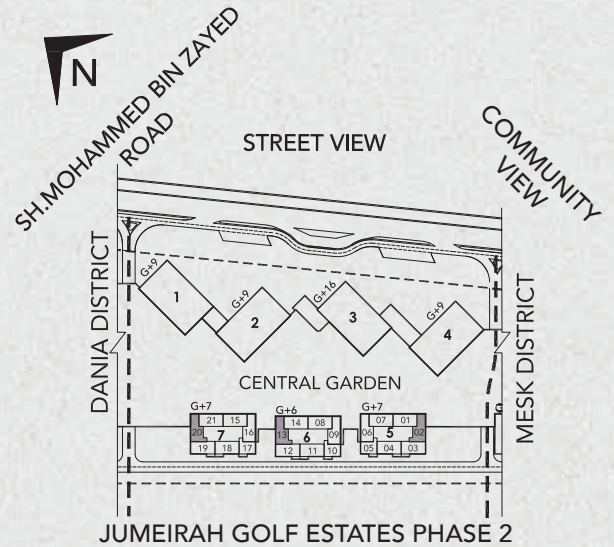
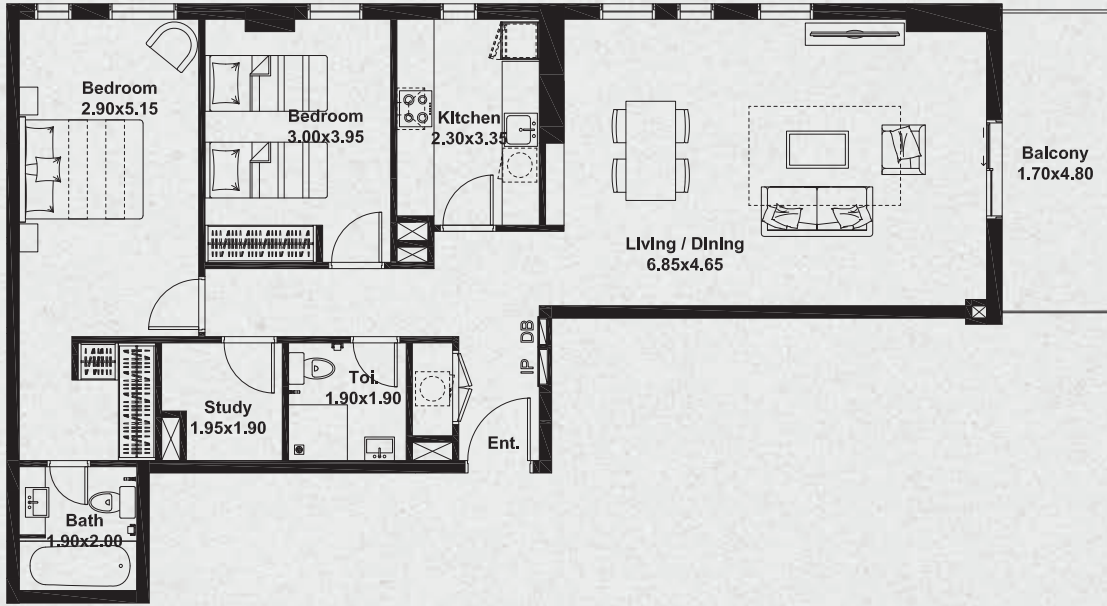

TYPE	LEVEL	UNIT (SQ.FT)	BALCONY (SQ.FT)	TOTAL (SQ.FT)
2BR/D	2-4	1,094	98	1,192
	5-6			
	7			

LEVEL 7



LEVEL 5-6

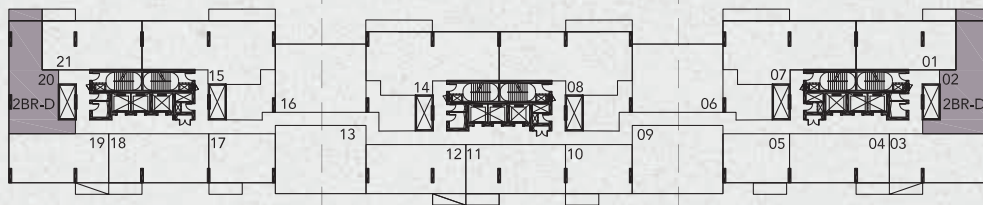

LEVEL 2-4

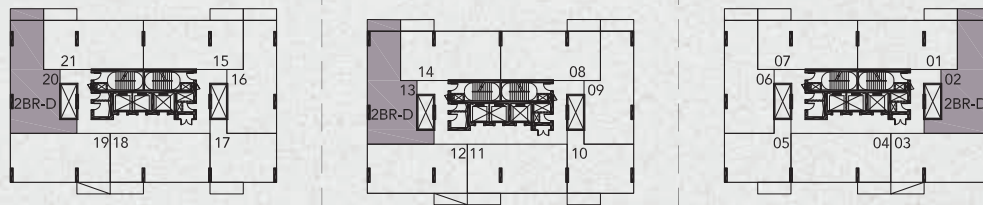

NOOR 7

NOOR 6

NOOR 5

نور 5, 6 & 7
شقة مكونة من غرفتي نوم - نموذج E
NOOR 5, 6 & 7
TWO BEDROOM APARTMENT - TYPE E

2BR/E

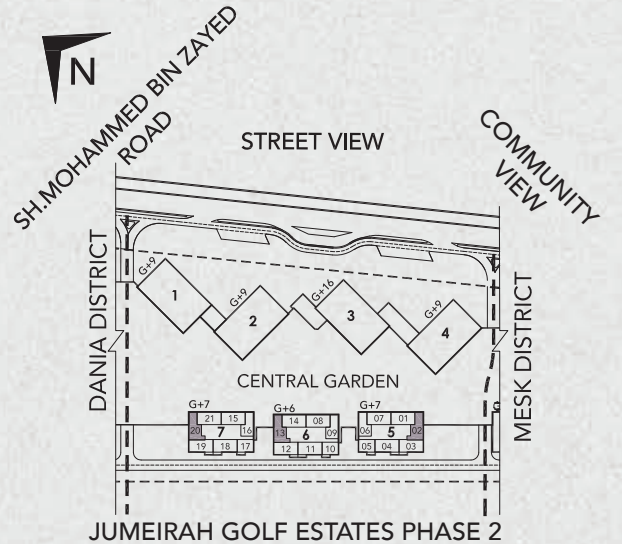
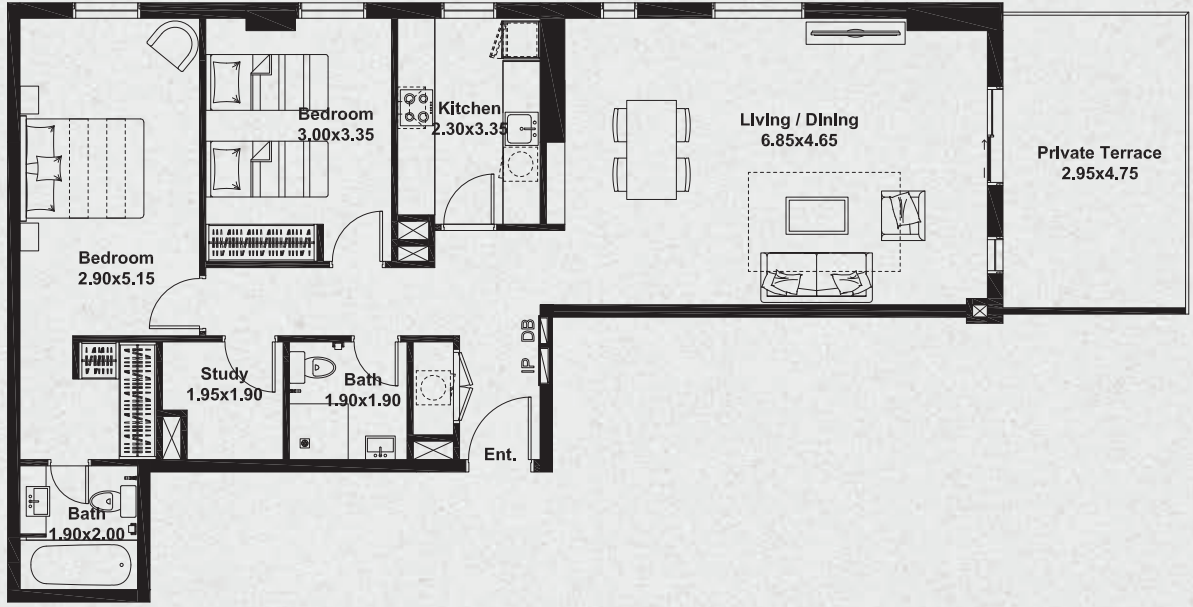

TYPE	LEVEL	UNIT (SQ.FT)	BALCONY (SQ.FT)	TOTAL (SQ.FT)
2BR/E	1	1,094	160	1,254

LEVEL 1

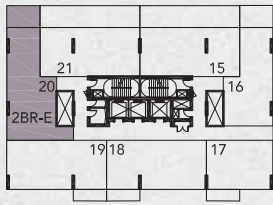

NOOR 7

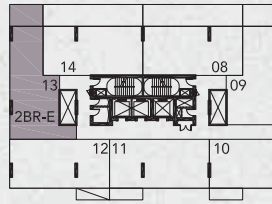

NOOR 6

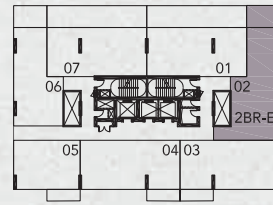

NOOR 5

نور 5, 6 & 7
شقة مكونة من غرفتي نوم - نموذج F
NOOR 5, 6 & 7
TWO BEDROOM APARTMENT - TYPE F

2BR/F

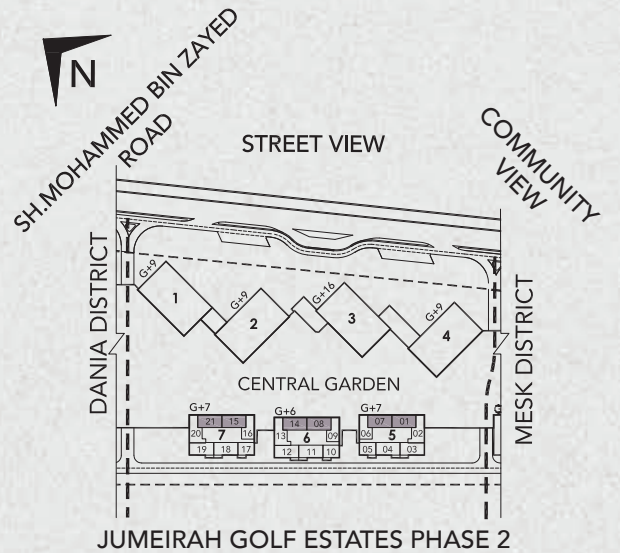
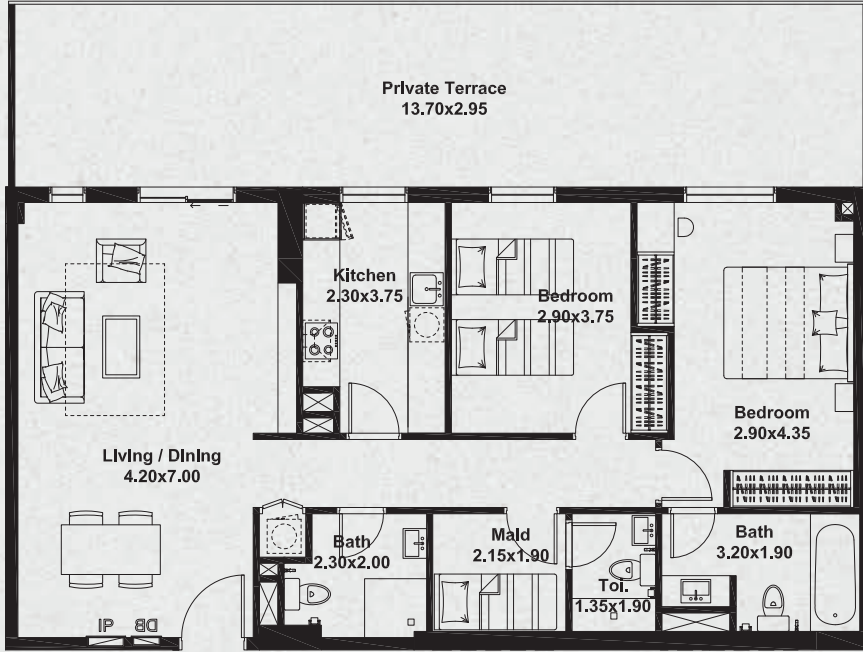

TYPE	LEVEL	UNIT (SQ.FT)	BALCONY (SQ.FT)	TOTAL (SQ.FT)
2BR/F	1	1,055	460	1,515

LEVEL 1

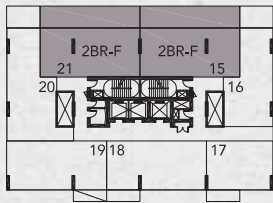

NOOR 7

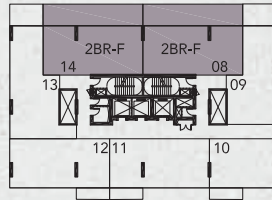

NOOR 6

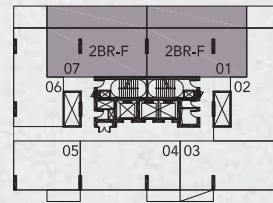

NOOR 5

نور 5, 6 & 7
شقة مكونة من غرفتي نوم - نموذج G
NOOR 5, 6 & 7
TWO BEDROOM APARTMENT - TYPE G

2BR/G

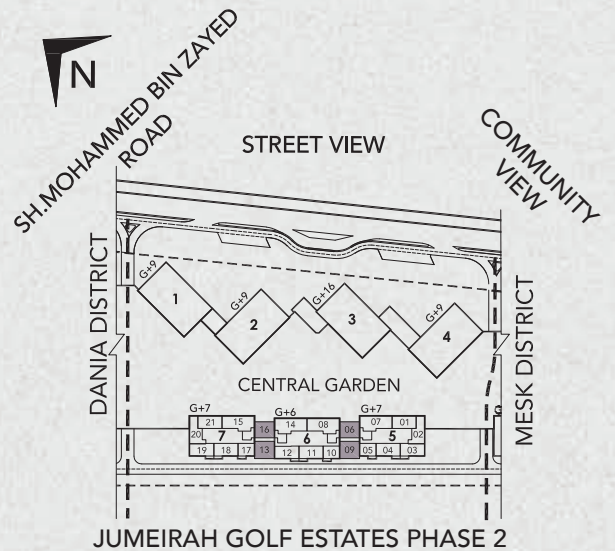
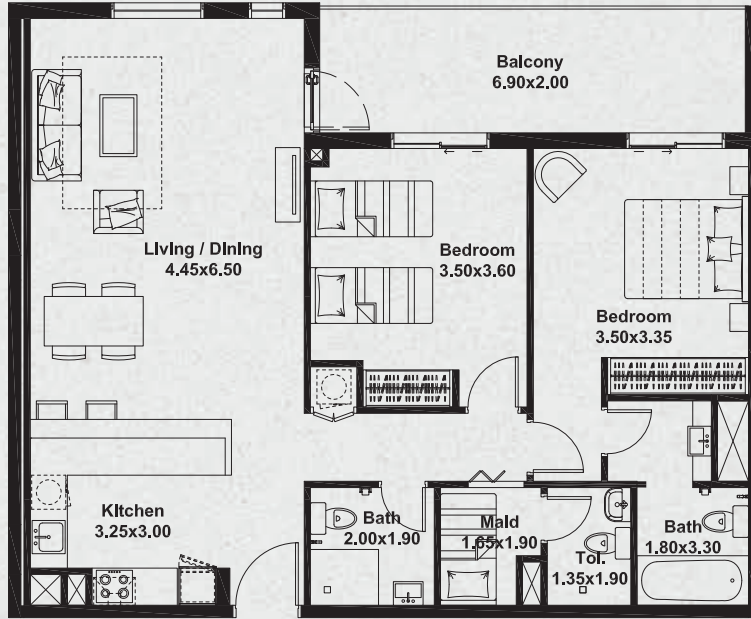

TYPE	LEVEL	UNIT (SQ.FT)	BALCONY (SQ.FT)	TOTAL (SQ.FT)
2BR/G	5-6	1,063	165	1,228
	5-6	1,105	133	1,238

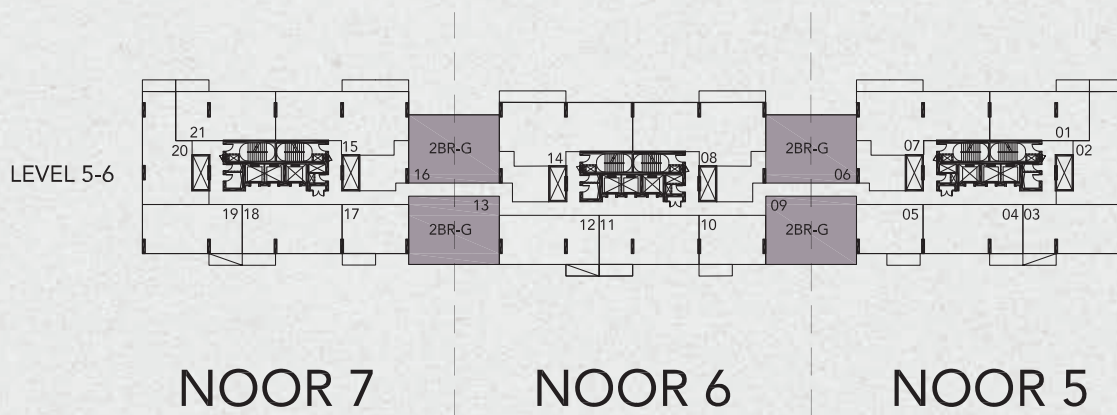

نور 5, 6 & 7
شقة مكونة من ثلاث غرف نوم - نموذج A
NOOR 5, 6 & 7
THREE BEDROOM APARTMENT - TYPE A

3BR/A

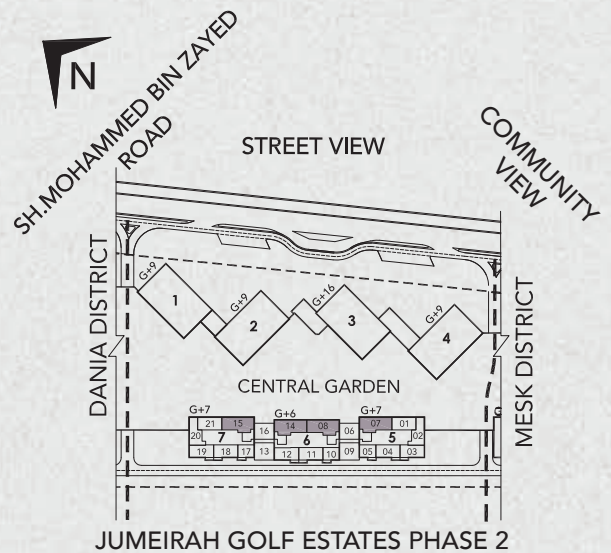
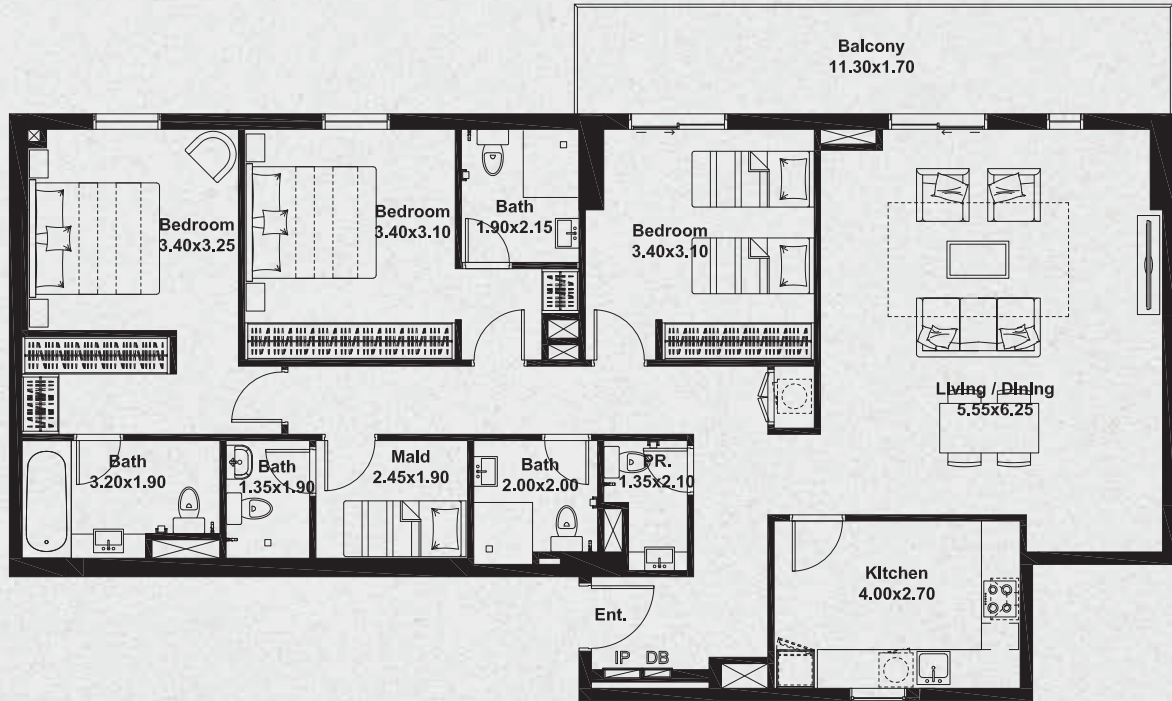

TYPE	LEVEL	UNIT (SQ.FT)	BALCONY (SQ.FT)	TOTAL (SQ.FT)
3BR/A	5-7	1,572	232	1,804

